

EM58 PT HS58 PT HM58 PT



- EM58 27-bit multiturn encoder for standard purposes
- HS58 18-bit singleturn encoder for high precision demands
- HM58 30-bit multiturn encoder for high end applications
- Encoder Profile Specifications V4.1 version 3.162
- RT real-time transmission & IRT isochronous real-time mode

Suitable for the following models:

- EM58, EM58S PT
- EMC58, EMC59, EMC60 PT
- HS58, HS58S PT
- HSC58, HSC59, HSC60 PT
- HM58, HM58S PT
- HMC58, HMC59, HMC60 PT

General Contents

| | |
|-------------------------|-----|
| Safety summary | 21 |
| Identification | 23 |
| Mechanical installation | 24 |
| Electrical connections | 26 |
| Getting started | 33 |
| Profinet interface | 66 |
| Default parameters list | 160 |

This publication was produced by Lika Electronic s.r.l. 2019. All rights reserved. Tutti i diritti riservati. Alle Rechte vorbehalten. Todos los derechos reservados. Tous droits réservés.

This document and information contained herein are the property of Lika Electronic s.r.l. and shall not be reproduced in whole or in part without prior written approval of Lika Electronic s.r.l. Translation, reproduction and total or partial modification (photostat copies, film and microfilm included and any other means) are forbidden without written authorisation of Lika Electronic s.r.l.

The information herein is subject to change without notice and should not be construed as a commitment by Lika Electronic s.r.l. Lika Electronic s.r.l. reserves the right to make all modifications at any moments and without forewarning.

This manual is periodically reviewed and revised. As required we suggest checking if a new or updated edition of this document is available at Lika Electronic s.r.l.'s website. Lika Electronic s.r.l. assumes no responsibility for any errors or omissions in this document. Critical evaluation of this manual by the user is welcomed. Your comments assist us in preparation of future documentation, in order to make it as clear and complete as possible. Please send an e-mail to the following address info@lika.it for submitting your comments, suggestions and criticisms.

The logo for Lika Electronic s.r.l. consists of the word "lika" in a bold, lowercase, sans-serif font. The letter "i" has a dot, and the "a" has a tail that curves slightly to the right.

Table of contents

| | |
|--|-----------|
| User's guide..... | 1 |
| Table of contents..... | 3 |
| Subject Index..... | 7 |
| Table of figures..... | 8 |
| Typographic and iconographic conventions..... | 10 |
| Preliminary information..... | 11 |
| Profinet certificates..... | 12 |
| Glossary of Profinet terms..... | 13 |
| List of abbreviations..... | 18 |
| References..... | 20 |
| 1 Safety summary..... | 21 |
| 1.1 Safety..... | 21 |
| 1.2 Electrical safety..... | 21 |
| 1.3 Mechanical safety..... | 22 |
| 2 Identification..... | 23 |
| 3 Mechanical installation..... | 24 |
| 3.1 Solid shaft encoders..... | 24 |
| 3.1.1 Customary installation..... | 24 |
| 3.1.2 Installation using fixing clamps (code LKM-386)..... | 25 |
| 3.1.3 Installation using a mounting bell (code PF4256)..... | 25 |
| 3.2 Hollow shaft encoders..... | 26 |
| 3.2.1 EMC58, HxC58..... | 26 |
| 3.2.2 EMC59, HxC59..... | 27 |
| 3.2.3 EMC60, HxC60..... | 28 |
| 4 Electrical connections..... | 29 |
| 4.1 PWR Power supply connector (Figure 1)..... | 29 |
| 4.2 P1 Port 1 and P2 Port 2 connectors (Figure 1)..... | 30 |
| 4.3 Network configuration: cables, hubs, switches - Recommendations..... | 30 |
| 4.4 Ground connection (Figure 1)..... | 31 |
| 4.5 MAC address and IP address..... | 31 |
| 4.6 Diagnostic LEDs (Figure 1)..... | 32 |
| 5 Getting started..... | 33 |
| 5.1 Quick start information..... | 33 |
| 5.1.1 Setting the resolution and the scaling function..... | 33 |
| 5.1.2 Reading the position..... | 34 |
| 5.1.3 Setting and executing the preset..... | 34 |
| 5.2 Configuring the encoder with Siemens SIMATIC STEP 7..... | 35 |
| 5.3 Mac address..... | 35 |
| 5.4 Encoder installation under STEP 7 environment..... | 36 |
| 5.4.1 Description of the GSDML file..... | 36 |
| 5.4.2 Installing the GSDML file..... | 37 |
| 5.4.3 Inserting the module in the Profinet-IO system..... | 40 |
| 5.4.4 Device name and IP address at delivery..... | 43 |
| 5.4.5 Setting the device name..... | 43 |
| 5.4.6 Checking the device name..... | 52 |

| | |
|---|-----------|
| 5.4.7 Setting the IP address..... | 53 |
| 5.5 Setting the parameters: Parameter Access Point..... | 57 |
| 5.6 Resetting the parameters to default factory values..... | 60 |
| 5.7 TO Technology Objects..... | 64 |
| 5.7.1 Properties of a technology object (TO)..... | 64 |
| 5.7.2 Installing the encoder as a technology object (TO)..... | 65 |
| 6 Profinet interface..... | 66 |
| 6.1 A brief introduction to Profinet..... | 66 |
| 6.2 Profinet encoders from Lika Electronic..... | 66 |
| 6.2.1 Overview of the encoder profiles..... | 68 |
| 6.3 Application Class definition..... | 68 |
| 6.3.1 Application Class 3..... | 68 |
| 6.3.2 Application Class 4..... | 68 |
| 6.4 Encoder Object model..... | 69 |
| 6.5 Encoder object architecture..... | 70 |
| 7 PROFINET IO data description..... | 71 |
| 7.1 Telegrams..... | 71 |
| 7.1.1 Standard Telegram 81..... | 71 |
| 7.1.2 Standard Telegram 82..... | 71 |
| 7.1.3 Standard Telegram 83..... | 72 |
| 7.1.4 Standard Telegram 84..... | 72 |
| 8 Cyclic Data Exchange – Std signals..... | 73 |
| 8.1 List of the available standard signals..... | 75 |
| G1_XIST1 | 75 |
| G1_XIST2 | 76 |
| G1_XIST3 | 76 |
| STW2_ENC | 77 |
| Control by PLC..... | 77 |
| Controller Sign-Of-Life..... | 77 |
| ZSW2_ENC | 78 |
| Control requested..... | 78 |
| Encoder Sign-Of-Life..... | 78 |
| G1_STW | 78 |
| Home position mode..... | 79 |
| Request set/shift of home position..... | 79 |
| Request absolute value cyclically..... | 81 |
| Activate parking sensor..... | 81 |
| Acknowledging a sensor error..... | 81 |
| G1_ZSW | 82 |
| Requirements of error acknowledge detected..... | 82 |
| Set/shift of home position executed..... | 82 |
| Transmit absolute value cyclically..... | 82 |
| Parking sensor active..... | 82 |
| Sensor error..... | 82 |
| NIST_A | 82 |
| NIST_B | 82 |
| 9 Acyclic Data Exchange..... | 83 |
| 9.1 Index 0xAFF0: Identification & Maintenance (I&M) functions..... | 84 |
| BLOCKHEADER | 84 |
| MANUFACTURER ID (VENDOR ID) | 84 |
| ORDER ID | 84 |

| | |
|--|-----------|
| SERIAL NUMBER..... | 84 |
| HARDWARE REVISION..... | 84 |
| SOFTWARE REVISION..... | 84 |
| REVISION COUNTER..... | 84 |
| PROFILE ID (API)..... | 84 |
| PROFILE SPECIFIC TYPE..... | 84 |
| IM VERSION..... | 84 |
| IM SUPPORTED..... | 84 |
| 9.2 Index 0xB02E : supported PROFIdrive specific parameters..... | 84 |
| P922 – Telegram Selection..... | 84 |
| P964 – Profidrive Parameter : Device identification..... | 84 |
| P965 – Encoder profile number..... | 85 |
| P971 – Transfer to non volatile memory..... | 85 |
| P975 – Encoder object identification..... | 85 |
| P979 – Sensor format..... | 86 |
| P980 – Number list of defined parameter..... | 86 |
| P61001 – IP of station..... | 86 |
| 9.3 Index 0xB02E : supported encoder specific parameters..... | 87 |
| P65000 – Preset value..... | 87 |
| P65001 – Operating status..... | 87 |
| Header..... | 87 |
| Operating status..... | 87 |
| Faults..... | 87 |
| Supported faults..... | 88 |
| Warnings..... | 88 |
| Supported warnings..... | 88 |
| Encoder profile version..... | 88 |
| Operating time..... | 88 |
| Offset value..... | 88 |
| Measuring units per revolution..... | 88 |
| Total measuring range in measuring units..... | 88 |
| Velocity measuring unit..... | 88 |
| Operating status table values..... | 88 |
| Faults table..... | 88 |
| Supported faults table..... | 89 |
| 9.4 Index 0xBF00 : user parameter data..... | 90 |
| Code sequence..... | 90 |
| Class 4 functionality..... | 91 |
| G1_XIST1 preset control..... | 91 |
| Scaling function control..... | 92 |
| Alarm channel control..... | 92 |
| Compatibility mode..... | 93 |
| Scaling function parameters..... | 93 |
| Measuring units / Revolution..... | 94 |
| Total measuring range..... | 94 |
| Maximum Master Sign-Of-Life failures..... | 95 |
| Velocity measuring units..... | 96 |
| 9.5 "Red Zone"..... | 97 |
| 10 Diagnostics and Alarms..... | 99 |
| 10.1 Acyclic diagnosis parameter P65001 – Operating status..... | 100 |

| | |
|---|------------|
| 10.2 Error messages via the Alarm Channel..... | 100 |
| 10.2.1 Use of the ChannelErrorType..... | 101 |
| Memory error..... | 101 |
| Commissioning diagnostic..... | 101 |
| 10.3 Error codes in G1_XIST2..... | 101 |
| Master's sign of life fault..... | 101 |
| Synchronization fault..... | 101 |
| Memory error..... | 101 |
| Parametrization error..... | 101 |
| 10.4 LED indication..... | 101 |
| 11 Real time class communication..... | 102 |
| 11.1 Real-time classes in PROFINET IO..... | 102 |
| 11.2 Real-Time class 2 (RT2) – Not synchronized..... | 102 |
| 11.2.1 Setting an anisochronous communication..... | 103 |
| 11.3 Real-Time class 3 (IRT_TOP) (RT3)..... | 104 |
| 11.3.1 Setting an isochronous communication..... | 105 |
| 11.4 OB61..... | 116 |
| 11.5 PIP (Process Image Partition)..... | 117 |
| 11.5.1 Consistency..... | 117 |
| 11.5.2 SFC126 "SYNC_PI"..... | 118 |
| 11.5.3 SFC127 "SYNC_PO"..... | 118 |
| 11.6 Domain Management..... | 119 |
| 11.7 Topology Editor..... | 123 |
| 11.8 Message monitoring..... | 127 |
| 12 Encoder replacement using LLDP..... | 128 |
| 13 Read & write in acyclic comm..... | 130 |
| 13.1 Example: reading and writing a parameter (Preset Value)..... | 131 |
| 13.1.1 System Function Block 52 (SFB52)..... | 131 |
| 13.1.2 System Function Block 53 (SFB53)..... | 131 |
| 13.1.3 Data Block 1 (DB1)..... | 132 |
| 13.1.4 Data Block 2 (DB2)..... | 132 |
| 13.1.5 Data Block 3 (DB3)..... | 133 |
| 13.1.6 Data Block 4 (DB4)..... | 133 |
| 13.1.7 Organization Block 1 (OB1)..... | 134 |
| 13.1.8 Function 1 (FC1)..... | 134 |
| 13.1.9 Function 2 (FC2)..... | 135 |
| 13.1.10 Acyclic request of Preset..... | 136 |
| 13.2 Monitoring a variable..... | 137 |
| 14 Encoder state machine..... | 138 |
| 14.1 Normal operation diagram..... | 139 |
| 14.2 Preset diagram..... | 140 |
| 14.3 Parking sensor diagram..... | 141 |
| 14.4 Error diagram..... | 142 |
| 14.4.1 Acknowledgement of acknowledgeable sensor error..... | 142 |
| 14.4.2 Acknowledgement of not acknowledgeable sensor error..... | 143 |
| 15 Integrated web server..... | 144 |
| 15.1 Firmware upgrade..... | 149 |
| 15.2 Setting the preset value..... | 156 |
| 16 Default parameters list..... | 160 |

Subject Index

| | |
|---|-----|
| A | |
| Acknowledging a sensor error..... | 81 |
| Activate parking sensor..... | 81 |
| Alarm channel control..... | 92 |
| B | |
| BLOCKHEADER..... | 84 |
| C | |
| Class 4 functionality..... | 91 |
| Code sequence..... | 90 |
| Commissioning diagnostic..... | 101 |
| Compatibility mode..... | 93 |
| Control by PLC..... | 77 |
| Control requested..... | 78 |
| Controller Sign-Of-Life..... | 77 |
| E | |
| Encoder Sign-Of-Life..... | 78 |
| G | |
| G1_STW..... | 78 |
| G1_XIST1..... | 75 |
| G1_XIST1 preset control..... | 91 |
| G1_XIST2..... | 76 |
| G1_XIST3..... | 76 |
| G1_ZSW..... | 82 |
| H | |
| HARDWARE REVISION..... | 84 |
| Home position mode..... | 79 |
| I | |
| IM SUPPORTED..... | 84 |
| IM VERSION..... | 84 |
| Index 0xAFF0..... | 84 |
| Index 0xB02E : supported encoder specific parameters..... | 87 |
| Index 0xB02E : supported PROFIdrive specific parameters..... | 84 |
| Index 0xBF00..... | 90 |
| M | |
| MANUFACTURER ID..... | 84 |
| Master's sign of life fault..... | 101 |
| Maximum Master Sign-Of-Life failures..... | 95 |
| Measuring units / Revolution..... | 94 |
| Memory error..... | 101 |
| N | |
| NIST_A..... | 82 |
| NIST_B..... | 82 |
| O | |
| ORDER ID..... | 84 |
| P | |
| P61001 – IP of station..... | 86 |
| P65000 – Preset value..... | 87 |
| P65001 – Operating status..... | 87 |
| P922 – Telegram Selection..... | 84 |
| P964 – Profidrive Parameter : Device identification..... | 84 |
| P965 – Encoder profile number..... | 85 |
| P971 – Transfer to non volatile memory..... | 85 |
| P975 – Encoder object identification..... | 85 |
| P979 – Sensor format..... | 86 |
| P980 – Number list of defined parameter..... | 86 |
| Parametrization error..... | 101 |
| Parking sensor active..... | 82 |
| PROFILE ID..... | 84 |
| PROFILE SPECIFIC TYPE..... | 84 |
| R | |
| Request absolute value cyclically..... | 81 |
| Request set/shift of home position..... | 79 |
| Requirements of error acknowledge detected | 82 |
| REVISION COUNTER..... | 84 |
| S | |
| Scaling function control..... | 92 |
| Sensor error..... | 82 |
| SERIAL NUMBER..... | 84 |
| Set/shift of home position executed..... | 82 |
| SOFTWARE REVISION..... | 84 |
| Standard Telegram 81..... | 71 |
| Standard Telegram 82..... | 71 |
| Standard Telegram 83..... | 72 |
| Standard Telegram 84..... | 72 |
| STW2_ENC..... | 77 |
| Synchronization fault..... | 101 |
| T | |
| Total measuring range..... | 94 |
| Transmit absolute value cyclically..... | 82 |
| V | |
| Velocity measuring units..... | 96 |
| Z | |
| ZSW2_ENC..... | 78 |

Table of figures

| | |
|---|-----|
| Figure 1 - Connectors and diagnostic LEDs..... | 29 |
| Figure 2 - Installing the GSDML file..... | 37 |
| Figure 3 - Selecting the GSDML file..... | 38 |
| Figure 4 - GSDML file installation..... | 38 |
| Figure 5 - Scrolling through Profinet families and categories..... | 39 |
| Figure 6 - Inserting a module in the Profinet-IO system..... | 40 |
| Figure 7 - Inserted module..... | 41 |
| Figure 8 - Adding the Standard Telegram..... | 42 |
| Figure 9 - Assigning the device name..... | 45 |
| Figure 10 - Assigning the IP address..... | 46 |
| Figure 11 - Downloading data to the PLC..... | 47 |
| Figure 12 - Assigning the device name..... | 48 |
| Figure 13 - Confirming the device name..... | 49 |
| Figure 14 - Edit Ethernet Node dialog box..... | 50 |
| Figure 15 - Edit Ethernet Node confirmation..... | 51 |
| Figure 16 - Browsing the network..... | 51 |
| Figure 17 - Verifying device name..... | 52 |
| Figure 18 - Verifying device name..... | 52 |
| Figure 19 - Setting the IP address..... | 53 |
| Figure 20 - Browsing the network..... | 54 |
| Figure 21 - Assigning IP configuration..... | 55 |
| Figure 22 - Edit Ethernet Node confirmation..... | 55 |
| Figure 23 - Browsing the network..... | 56 |
| Figure 24 - Entering the Parameter Access Point dialog box..... | 57 |
| Figure 25 - Parameter Access Point properties..... | 58 |
| Figure 26 - Downloading data to the PLC..... | 59 |
| Figure 27 - Parameter Access Point help messages..... | 59 |
| Figure 28 - Restoring default values..... | 61 |
| Figure 29 - Reset to factory settings..... | 62 |
| Figure 30 - Reset first confirmation message..... | 62 |
| Figure 31 - Reset second confirmation message..... | 63 |
| Figure 32 - Reset executed message..... | 63 |
| Figure 33 - Checking data after reset..... | 64 |
| Figure 34 - Checking the Compatibility mode parameter setting..... | 65 |
| Figure 35 - Setting the Not synchronized role of the IO controller..... | 103 |
| Figure 36 - Setting the Not synchronized role of the IO device..... | 104 |
| Figure 37 - Setting the sync master role of the IO controller..... | 105 |
| Figure 38 - Setting the sync slave role of the IO device..... | 106 |
| Figure 39 - CPU property sheet..... | 107 |
| Figure 40 - PIP of OB61..... | 108 |
| Figure 41 - OB61: assigning IO device in isochronous mode..... | 109 |
| Figure 42 - Standard Telegram as isochronous submodule..... | 110 |
| Figure 43 - Setting PIP for Standard Telegram IOs..... | 111 |
| Figure 44- Configuring the IO controller topology..... | 112 |



| | |
|---|-----|
| Figure 45 - Configuring the IO device topology..... | 113 |
| Figure 46 - Checking the Profinet IO isochronous mode..... | 114 |
| Figure 47 - Isochronous Mode dialog box..... | 115 |
| Figure 48 - OB61..... | 116 |
| Figure 49 - Process Image Partition..... | 117 |
| Figure 50 - Assigning the IO device to a sync domain..... | 120 |
| Figure 51 - Domain management dialog box..... | 121 |
| Figure 52 - Sync domain details dialog box..... | 122 |
| Figure 53 - Entering the Topology Editor..... | 123 |
| Figure 54 - Topology Editor: Table view..... | 124 |
| Figure 55 - Topology Editor: Offline/Online comparison..... | 125 |
| Figure 56 - Topology Editor: Graphic view..... | 126 |
| Figure 57 - Message monitoring..... | 127 |
| Figure 58 - Link Layer Discovery Protocol (LLDP)..... | 128 |
| Figure 59 - Base mode parameter request and response..... | 130 |
| Figure 60 - SFB52..... | 131 |
| Figure 61 - SFB53..... | 131 |
| Figure 62 - DB1..... | 132 |
| Figure 63 - DB2..... | 132 |
| Figure 64 - DB3..... | 133 |
| Figure 65 - DB4..... | 133 |
| Figure 66 - OB1..... | 134 |
| Figure 67 - FC1..... | 134 |
| Figure 68 - FC1..... | 135 |
| Figure 69 - FC2..... | 135 |
| Figure 70 - Acyclic request of Preset value..... | 136 |
| Figure 71 - Monitoring a variable..... | 137 |
| Figure 72 - Encoder state machine..... | 138 |
| Figure 73 - Opening the web server..... | 145 |
| Figure 74 - Web server Home page..... | 145 |
| Figure 75 - Encoder Information page..... | 146 |
| Figure 76 - Encoder position page..... | 147 |
| Figure 77 - Change the preset value page..... | 147 |
| Figure 78 - Firmware upgrade page..... | 148 |
| Figure 79 - Opening the web server..... | 150 |
| Figure 80 - Web server Home page..... | 151 |
| Figure 81 - Confirming the access to the Firmware upgrade page..... | 151 |
| Figure 82 - Firmware upgrade page..... | 152 |
| Figure 83 - Web server stopped..... | 152 |
| Figure 84 - Web server stopped..... | 153 |
| Figure 85 - Firmware upgrade executable file..... | 153 |
| Figure 86 - Starting the firmware upgrade operation..... | 154 |
| Figure 87 - Firmware upgrade operation process..... | 155 |
| Figure 88 - Opening the web server..... | 156 |
| Figure 89 - Web server Home page..... | 157 |
| Figure 90 - Confirming the access to the Preset page..... | 157 |
| Figure 91 - Changing the Preset value..... | 158 |
| Figure 92 - Preset value stored properly..... | 159 |
| Figure 93 - Preset value already stored..... | 159 |

Typographic and iconographic conventions

In this guide, to make it easier to understand and read the text the following typographic and iconographic conventions are used:

- parameters and objects of both Lika device and interface are coloured in **GREEN**;
- alarms are coloured in **RED**;
- states are coloured in **FUCSIA**.

When scrolling through the text some icons can be found on the side of the page: they are expressly designed to highlight the parts of the text which are of great interest and significance for the user. Sometimes they are used to warn against dangers or potential sources of danger arising from the use of the device. You are advised to follow strictly the instructions given in this guide in order to guarantee the safety of the user and ensure the performance of the device. In this guide the following symbols are used:

| | |
|---|--|
|  | This icon, followed by the word WARNING , is meant to highlight the parts of the text where information of great significance for the user can be found: user must pay the greatest attention to them! Instructions must be followed strictly in order to guarantee the safety of the user and a correct use of the device. Failure to heed a warning or comply with instructions could lead to personal injury and/or damage to the unit or other equipment. |
|  | This icon, followed by the word NOTE , is meant to highlight the parts of the text where important notes needful for a correct and reliable use of the device can be found. User must pay attention to them! Failure to comply with instructions could cause the equipment to be set wrongly: hence a faulty and improper working of the device could be the consequence. |
|  | This icon is meant to highlight the parts of the text where suggestions useful for making it easier to set the device and optimize performance and reliability can be found. Sometimes this symbol is followed by the word EXAMPLE when instructions for setting parameters are accompanied by examples to clarify the explanation. |

Preliminary information

This guide is designed to provide the most complete information the operator needs to correctly and safely install and operate the following encoders **fitted with Profinet interface**:

EMxxx13/16384PT-xx (DAP 1 : multiturn encoder 13 +14 bits)

HSxxx18/PT-xx (DAP 2 : singleturn encoder 18 bits)

HMxxx16/16384PT-xx (DAP 3 : multiturn encoder 16 +14 bits)

To make it easier to read the text, this guide can be divided into some main sections.

In the first section (from chapter 1 to chapter 4) general information concerning the safety, the mechanical installation and the electrical connection.

In the second section (chapter 5) information on how to install and configure the encoder in the STEP 7 development environment as well as tips for setting up and running properly and efficiently the unit are provided.

In the third section (from chapter 6 to chapter 12) both general and specific information is given on the Profinet interface. In this section the interface features and the parameters implemented in the unit are fully described.

In the last section (from chapter 13 to chapter 15) some examples of programming and advanced maintenance information are explained.



Lika Electronic Profinet encoder documentation is complete with an **example project** provided free of charge. This program is designed to make your own project planning, programming, communication and diagnostics with the STEP 7 V5.5 + SP1 development environment user-friendly and reliable. You can find it in the **Lika Step 7 Profinet example project.zip** compressed file contained in the **SW Hx58x PT.zip** file.



WARNING

If the encoder is used as a **TO Technology Object**, please refer to the "5.7 TO Technology Objects" section on page 64.

Profinet certificates



Glossary of Profinet terms

PROFINET IO, like many other networking systems, has a set of unique terminology. Table below contains a few of the technical terms used in this guide to describe the PROFINET IO interface. Sometimes they also refer more specifically to the S7 programming environment. They are listed in alphabetical order.

| | |
|-------------------------------|---|
| Acyclic Communications | Unscheduled, on demand communications. Diagnostic messages from an IO Supervisor to an IO Device are Acyclic. Refer to page 83. |
| AP | Application Process - The application process running in the device. PROFINET supports a default Application Processes and additional profile specific application processes. |
| API | The value of the API (Application Process Identifier) parameter specifies the application that is processing the IO data. PROFINET standard IEC 61158 assigns profiles to certain APIs (PROFIdrive, PROFIslave) which are defined by the PROFINET User Organization. The standard API is 0. |
| Application class | An application class specifies a number of mandatory functions and addition optional functions to be supported by an IO device. The Profinet encoders can be configured as CLASS 3 and CLASS 4 PROFINET IO devices according to the encoder profile. Refer to page 68. |
| AR | Application Relation - The relationship between a PROFINET IO Controller and an IO device. A PROFINET IO device can support more than one Application Relationship. |
| Bus | A bus is a communication medium connecting several nodes. Data can be transferred via serial or parallel circuits, that is, via electrical conductors or fiber optic. |
| Channel | A single IO point. A Channel can be discrete or analog. |
| Consumer Status | The Status an IO device provides to an IO Controller for the data it consumes from IO Controller. |
| CR | Communication Relationship - A virtual communication channel within an AR. |
| Cyclic Communications | Scheduled, repetitive communications. IO data and alarm transfers are cyclic. |
| Data block | In contrast to code blocks, data blocks (DB) do not contain Step 7 statements. They are used to save data, i.e. variable data which are processed by the user program. Global data blocks serve to accommodate user data which can be used by all other blocks. |
| DCP | Discovery Control Protocol - A communications protocol with PROFINET IO that allows an IO Controller or Supervisor to find every PROFINET IO device on a subnet. |

| | |
|----------------------------|---|
| Determinism | Determinism means that a system responds in a predictable (deterministic) manner. |
| Device name | Before an IO device can be addressed by an IO controller, it must have a device name. In PROFINET, this method was selected because it is simpler to work with names than with complex IP addresses. Refer to page 43. |
| Encoder Profile | The PROFINET profile for Encoders is intended to define a standard application interface for encoders. The profile is a supplement to the PROFIdrive profile, so it is mandatory to read the PROFIdrive profile before implementing the encoder profile. Profinet encoders from Lika Electronic comply with the Encoder Profile Specifications V4.1 version 3.162. See also "Profile". |
| Function | Functions (FC) are code blocks which can be programmed by the user. A FC does not have a "memory". Temporary variables as well as parameters transferred to the function when the latter is called are saved in a L stack. They are lost following processing of the FC. |
| Function block | Function blocks (FB) are code blocks with a "memory" which are programmed by the user. They have an assigned instance data block (instance DB) as memory. Parameters transferred to a FB as well as the static variables are saved in this data block. An FB contains a program which is always executed when the FB is called by another code block. Function blocks facilitate the programming of frequently repeated, complex functions. |
| Frame ID | The two-byte field in the Ethernet frame which defines the type of PROFINET IO message. |
| GSD | The properties of a PROFINET device are described in a GSD file (General Station Description) that contains all the information required for configuration. In PROFINET IO, the GSD file is in XML format. The structure of the GSD file conforms to ISO 15734, which is the world-wide standard for device descriptions. Refer to page 36. |
| GSDML | General Station Description Markup Language – The file containing the XML description of the PROFINET IO device. Refer to page 36. |
| IO Controller | Device used to address the connected IO devices. This means that the IO controller exchanges input and output signals with assigned field devices. The IO controller is often the controller on which the automation program runs. Refer to page 66. |
| IO Device | A decentralized field device that is assigned to one of the IO controllers (e.g. remote IO, encoders, valve terminals, frequency converters, switches, etc.). Refer to page 66. |
| IO Parameter Server | An IO Parameter Server is a server station, usually a PC, for loading and saving the configuration data (records) of IO Devices. |
| IO Supervisor | Programming device, PC or HMI device used for |

| | |
|---------------------------|---|
| | commissioning and diagnostics of IO Controllers and IO Devices. Refer to page 66. |
| IP address | The IP address is the name of the unit in a network using the Internet protocol. Refer to page 31. |
| IRT | Synchronized transmission procedure for the cyclic exchange of IRT data between PROFINET devices. A reserved bandwidth within the send clock is available for the IRT IO data. The reserved bandwidth ensures that the IRT data can be transmitted at reserved, synchronized intervals whilst remaining uninfluenced even by other greater network loads (e.g. TCP/IP communication or additional real time communication). The "high flexibility" enables simple planning and expansion of the system. A topological configuration is not required. Refer to page 102. |
| MAC address | The MAC address is an identifier unique worldwide consisting of two parts: the first 3 bytes are the manufacturer ID and are provided by IEE standard authority; the last three bytes represent a consecutive number of the manufacturer. Refer to page 31. |
| Module | Modules are user defined components that plug into slots. Modules can be real or virtual. |
| NRT | Non Real Time - The non Real Time PROFINET IO Channel. Configuration and diagnostic messages are transferred over the NRT Channel. |
| Organization block | A range of organization blocks (OB) are designed to execute the user program. OBs are the interface interface between the user program and the operating system of a CPU. They permit event-controlled processing of special program components within the user program. The order in which the user program is executed is defined in the organization blocks. |
| Profile | Profiles define application-specific functionality to ensure the openness of PROFIBUS and PROFINET is utilized consistently. PI Profiles can cover simple devices such as encoders by defining how signals are used and how they are physically connected. However, profiles are increasingly covered more complex systems or requirements. Profiles such as PROFIdrive and PROFIsafe deliver active functionality as well. An advanced profile covering active power management for end devices like lasers and robots is now under development with the aim of bringing significant reductions in energy consumption for the automotive industry. Profiles guarantee quicker system design and they support faster device interchange, promoting competition amongst vendors, increased choice for users and full interoperability. |
| Provider Status | The Status an IO device provides to an IO Controller with the data transferred to the Controller. |
| Proxy | A device which maps non PROFINET IO data to PROFINet. |

| | |
|------------------------------|---|
| Real-time | Real-time means that a system processes external events within a defined time. If the reaction of a system is predictable, one speaks of a deterministic system. The general requirements for real-time are therefore: deterministic response and defined response time. Refer to page 102. |
| RT | Real Time - The Real Time PROFINET IO Channel. I/O and Alarm Data are transferred over the RT Channel. Refer to page 102. |
| Slot | A group of one or more Subslots. Slots can be real or virtual. |
| Standard signal | The encoder profile defines a series of standard signals which are used to configure the IO data. Refer to page 73. |
| Submodule | A component of a module that is plugged into a subslot. A submodule is real or virtual. |
| Subslot | A group of one or more channels. Subslots can be real or virtual. |
| Sync domain | All PROFINET devices that are to be synchronized via PROFINET IO with IRT must belong to a sync domain. The sync domain consists of precisely one sync master and at least one sync slave. IO controllers and switches can hold the role of a sync master or sync slave. Other IO devices support only the role as sync slave. Refer to page 119. |
| System function | System functions (SFC) are integral functions in the operating system of a S7 CPU. In addition, SFCs are frequently called implicitly by SFBs. SFCs can be called by the user program like normal functions. SFCs are used to implement a number of important system functions for Profinet IO. |
| System function block | System function blocks (SFB) are integral functions in the operating system of a S7 CPU. SFBs can be called by the user program like normal function blocks. SFBs are used to implement a number of important system functions for Profinet IO. |
| TCP/IP | <p>The Ethernet system is designed solely to carry data. It is comparable to a highway as a system for transporting goods and passengers. The data is actually transported by protocols. This is comparable to cars and commercial vehicles transporting passengers and goods on the highway.</p> <p>Tasks handled by the basic Transmission Control Protocol (TCP) and Internet Protocol (IP) (abbreviated to TCP/IP):</p> <ol style="list-style-type: none"> 1. The sender splits the data into a sequence of packets. 2. The packets are transported over the Ethernet to the correct recipient. 3. The recipient reassembles the data packets in the correct order. 4. Faulty packets are sent again until the recipient acknowledges that they have been transferred successfully. |
| Telegram | A telegram is a rigidly defined bit stream carrying data. A telegram specifies the data length and the type of data which |

| | |
|--------------------------|--|
| | is sent to and from the IO controller. The encoder profile supports Standard Telegrams 81, 82, 83 and 84. Refer to page 71. |
| Topology | Network structure. Commonly used structures: <ul style="list-style-type: none"> • Line topology; • Ring topology; • Star topology; • Tree topology. Refer to page 123. |
| Transmission rate | Data transfer rate (in bps). |
| User program | The user program contains all instructions, declarations and data for signal processing required to control a plant or a process. It is assigned to a programmable module (for example CPU) and can be structured in smaller units (blocks). |

List of abbreviations

Table below contains a list of abbreviations (in alphabetical order) which may be used in this guide to describe the PROFINET IO interface. Sometimes they also refer more specifically to the S7 programming environment.

| | |
|-----------------|---|
| AR | Application Relation |
| API | Application Process Identifier |
| C-LS | Controller's Sign-Of-Life |
| CR | Communication Relation |
| DB | Data block |
| DO | Drive Object |
| DO-LS | Driver Object Sign-Of-Life |
| DU | Drive Unit |
| EO | Encoder Object |
| EU | Encoder Unit |
| FB | Function block |
| FC | Function |
| I&M | Identification & Maintenance |
| IRT | Isochronous Real Time Ethernet |
| IRT Flex | IRT "High Flexibility" |
| IRT Top | IRT "High Performance" |
| GSDML | General Station Description Markup Language |
| IO | Input/Output |
| IP | Internet Protocol |
| LLDP | Link Layer Discovery Protocol |
| LS | Sign-Of-Life |
| MAC | Media Access Control |
| MAP | Module Access Point |
| MLS | Master Sign-Of-Life |
| OB | Organization block |
| PAP | Parameter Access Point |
| PI | PROFIBUS and PROFINET International |
| RT | Real Time Ethernet |

| | |
|-------------------------|-------------------------------|
| SFB | System function block |
| SFC | System function |
| TCP | Transmission Control Protocol |
| T_{MAPC} | Master Application Cycle Time |

References

- 1- Profile encoder. Technical Specification for PROFIBUS and PROFINET related to PROFdrive Version 4.1
December 2008 Order No: 3.162
- 2- Profile Drive Technology PROFdrive. Technical Specification for PROFIBUS and PROFINET Version 4.1
May 2006 Order No: 3.172
- 3- Profile Guidelines Part 1: Identification & Maintenance Functions. Guideline for PROFIBUS and PROFINET Version 1.2 October 2009 Order No: 3.502
- 4- Profibus Guidelines: Profibus Interconnection Technology Version V1.4 Order No: 2.142
- 5- Profinet Guidelines: Profinet Cabling and Interconnection Version V1.8 Order No: 2.252

1 Safety summary



1.1 Safety

- Always adhere to the professional safety and accident prevention regulations applicable to your country during device installation and operation;
- installation and maintenance operations have to be carried out by qualified personnel only, with power supply disconnected and stationary mechanical parts;
- device must be used only for the purpose appropriate to its design: use for purposes other than those for which it has been designed could result in serious personal and/or the environment damage;
- high current, voltage and moving mechanical parts can cause serious or fatal injury;
- warning ! Do not use in explosive or flammable areas;
- failure to comply with these precautions or with specific warnings elsewhere in this manual violates safety standards of design, manufacture, and intended use of the equipment;
- Lika Electronic assumes no liability for the customer's failure to comply with these requirements.



1.2 Electrical safety

- Turn OFF power supply before connecting the device;
- connect according to explanation in the "Electrical connections" section on page 29;
- in compliance with 2014/30/EU norm on electromagnetic compatibility, following precautions must be taken:
 - before handling and installing the equipment, discharge electrical charge from your body and tools which may come in touch with the device;
 - power supply must be stabilized without noise; install EMC filters on device power supply if needed;
 - always use shielded cables (twisted pair cables whenever possible);
 - avoid cables runs longer than necessary;
 - avoid running the signal cable near high voltage power cables;
 - mount the device as far as possible from any capacitive or inductive noise source; shield the device from noise source if needed;
 - to guarantee a correct working of the device, avoid using strong magnets on or near by the unit;
 - minimize noise by connecting the shield and/or the connector housing and/or the frame to ground. Make sure that ground is not affected by



noise. The connection point to ground can be situated both on the device side and on user's side. The best solution to minimize the interference must be carried out by the user. Provide the ground connection as close as possible to the encoder. We suggest using the ground point provided in the cap, use one TCEI M3 x 6 cylindrical head screw with two tooth lock washers.



1.3 Mechanical safety

- Install the device following strictly the information in the "Mechanical installation" section on page 24;
- mechanical installation has to be carried out with stationary mechanical parts;
- do not disassemble the unit;
- do not tool the unit or its shaft;
- delicate electronic equipment: handle with care; do not subject the device and the shaft to knocks or shocks;
- respect the environmental characteristics of the product;
- unit with solid shaft: in order to guarantee maximum reliability over time of mechanical parts, we recommend a flexible coupling to be installed to connect the encoder and user's shaft; make sure the misalignment tolerances of the flexible coupling are respected;
- unit with hollow shaft: the encoder can be mounted directly on a shaft whose diameter has to respect the technical characteristics specified in the purchase order and clamped by means of the collar and, when requested, the anti-rotation pin.

2 Identification

Device can be identified through the **order code**, the **serial number** and the **MAC address** printed on the label applied to its body. Information is listed in the delivery document too. Please always quote the order code, the serial number and the MAC address when reaching Lika Electronic for purchasing spare parts or needing assistance. For any information on the technical characteristics of the product refer to the technical catalogue.



Warning: encoders having order code ending with "/Sxxx" may have mechanical and electrical characteristics different from standard and be supplied with additional documentation for special connections (Technical info).

3 Mechanical installation



WARNING

Installation and maintenance operations have to be carried out by qualified personnel only, with power supply disconnected. Shaft and mechanical components must be in stop.

For any information on the mechanical data and the electrical characteristics of the encoder please refer to the [technical catalogue](#).

3.1 Solid shaft encoders

- Mount the flexible coupling **1** on the encoder shaft;
- fix the encoder to the flange **2** (or to the mounting bell) by means of the screws **3**;
- secure the flange **2** to the support (or the mounting bell to the motor);
- mount the flexible coupling **1** on the motor shaft;
- make sure the alignment tolerances of the flexible coupling **1** are respected.

3.1.1 Customary installation

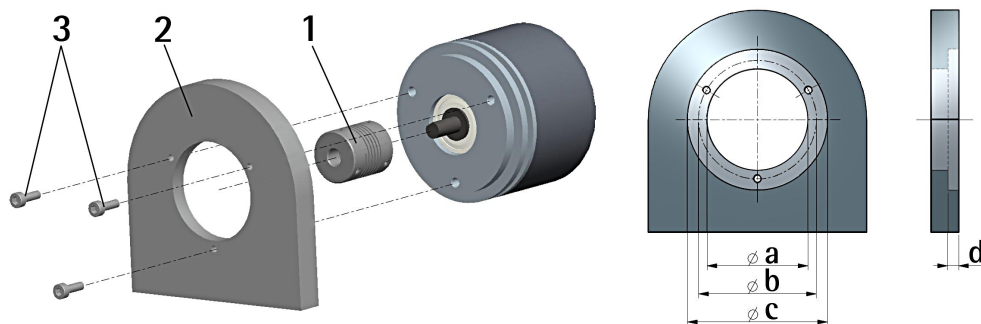

| | a [mm] | b [mm] | c [mm] | d [mm] |
|--------------|--------|--------|--------|--------|
| EM58, Hx58 | - | 42 | 50 F7 | 4 |
| EM58S, Hx58S | 36 H7 | 48 | - | - |

3.1.2 Installation using fixing clamps (code LKM-386)

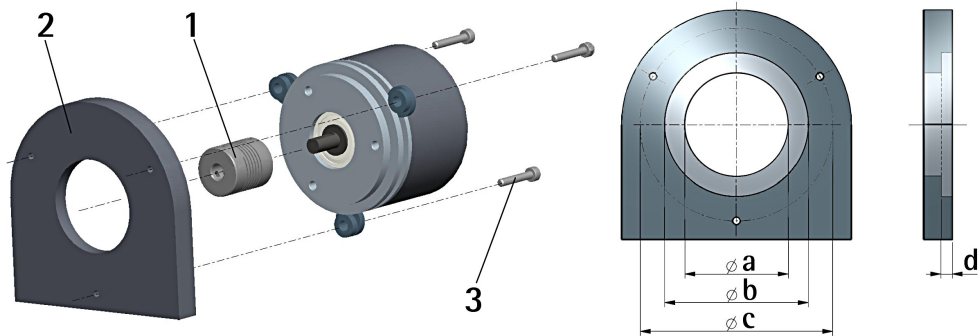

| | a [mm] | b [mm] | c [mm] | d [mm] |
|--------------|--------|--------|--------|--------|
| EM58, Hx58 | - | 50 F7 | 67 | 4 |
| EM58S, Hx58S | 36 H7 | - | 67 | - |

3.1.3 Installation using a mounting bell (code PF4256)

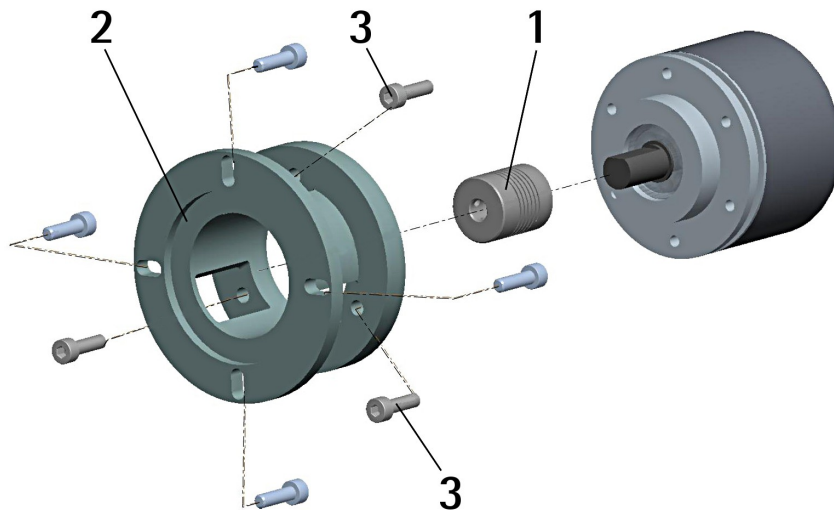

NOTE

In order to guarantee reliability over time of the encoder mechanical parts, we recommend a flexible coupling to be installed between the encoder and the motor shaft. Make sure the misalignment tolerances of the flexible coupling are respected.

3.2 Hollow shaft encoders

3.2.1 EMC58, HxC58

- Fasten the anti-rotation pin **1** to the rear of the motor (secure it using a locknut);
- mount the encoder on the motor shaft using the reducing sleeve **8** (if supplied). Avoid forcing the encoder shaft;
- insert the anti-rotation pin **1** into the slot on the flange of the encoder; this secures it in place by grub screw **2**, preset at Lika;
- fix the collar **3** to the encoder shaft (apply threadlocker to screw **3**).

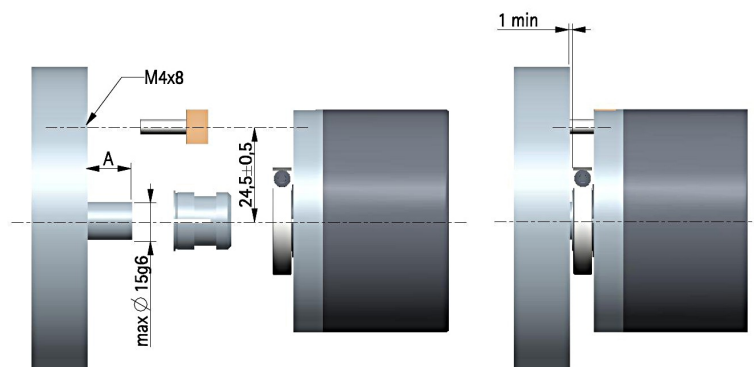
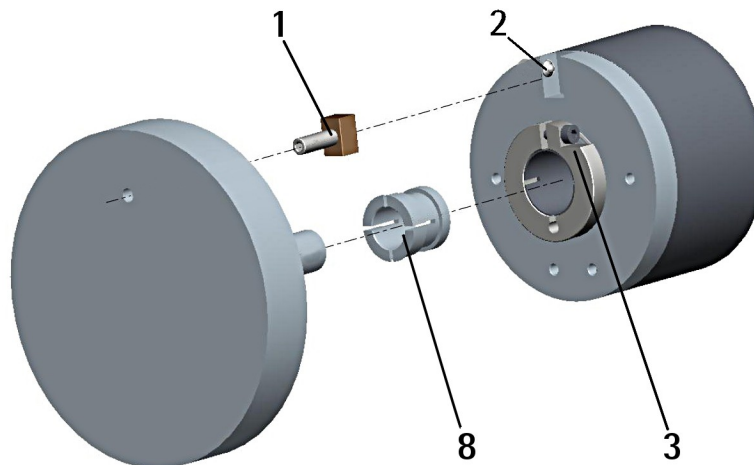

3.2.2 EMC59, HxC59

- Mount the encoder on the motor shaft using the reducing sleeve **8** (if supplied). Avoid forcing the encoder shaft;
- fasten the fixing plate **4** to the rear of the motor using two M3 cylindrical head screws **5**;
- fix the collar **3** to the encoder shaft (apply threadlocker to screw **3**).

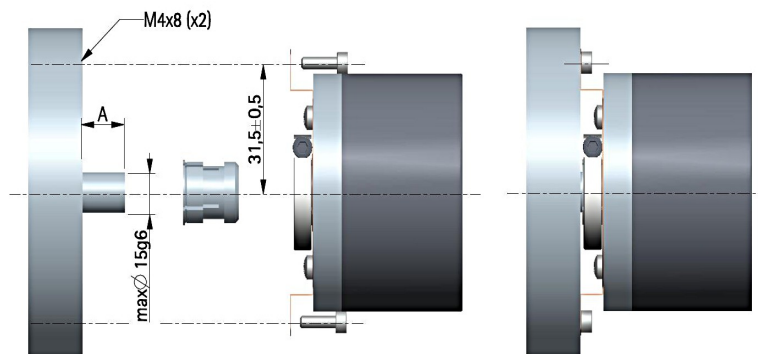
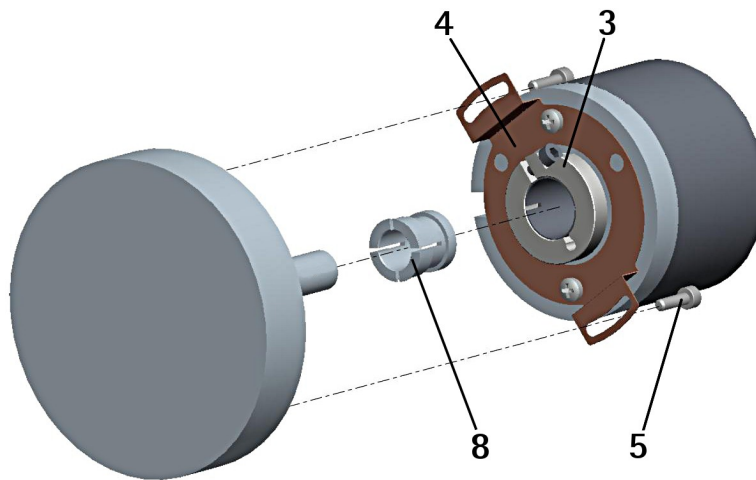

3.2.3 EMC60, HxC60

- Fix the tempered pin **6** to the rear of the motor;
- mount the encoder on the motor shaft using the reducing sleeve **8** (if supplied). Avoid forcing the encoder shaft;
- make sure the anti-rotation pin **6** is inserted properly into the fixing plate **7**;
- fix the collar **3** to the encoder shaft (apply threadlocker to screw **3**).

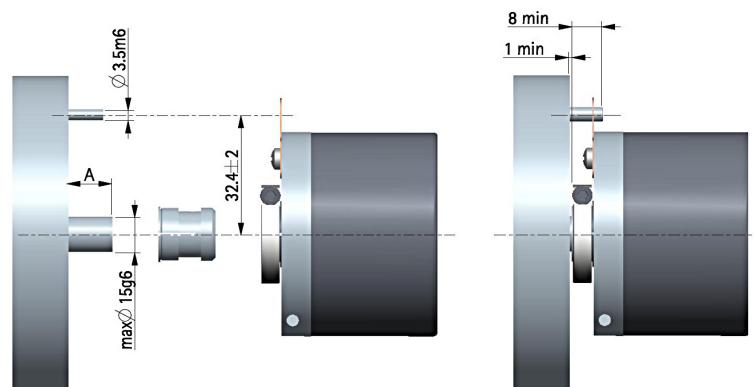
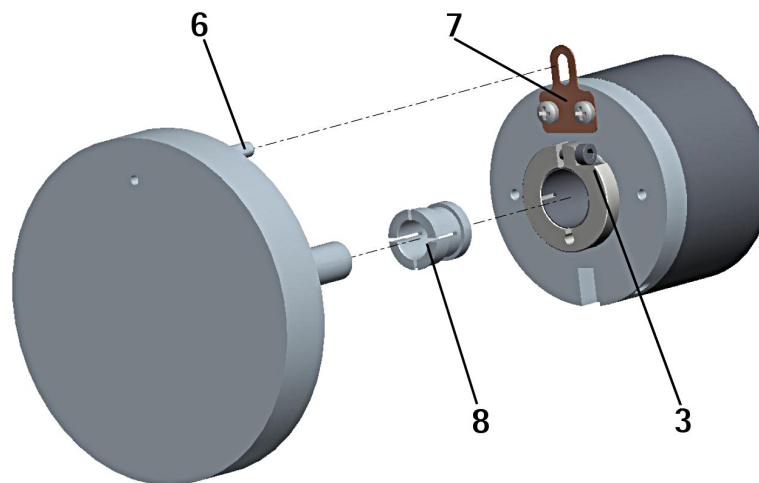

NOTE

You are strongly advised not to carry out any mechanical operations (drilling, milling, etc.) on the encoder shaft. This could cause serious damages to the internal parts and an immediate warranty loss. Please contact our technical personnel for the complete availability of "custom made" shafts.

4 Electrical connections



WARNING

Installation, electrical connection and maintenance operations must be carried out by qualified personnel only, with power supply disconnected. Mechanical components must be in stop.

For any information on the mechanical and electrical characteristics of the encoder please [refer to the technical catalogue](#).

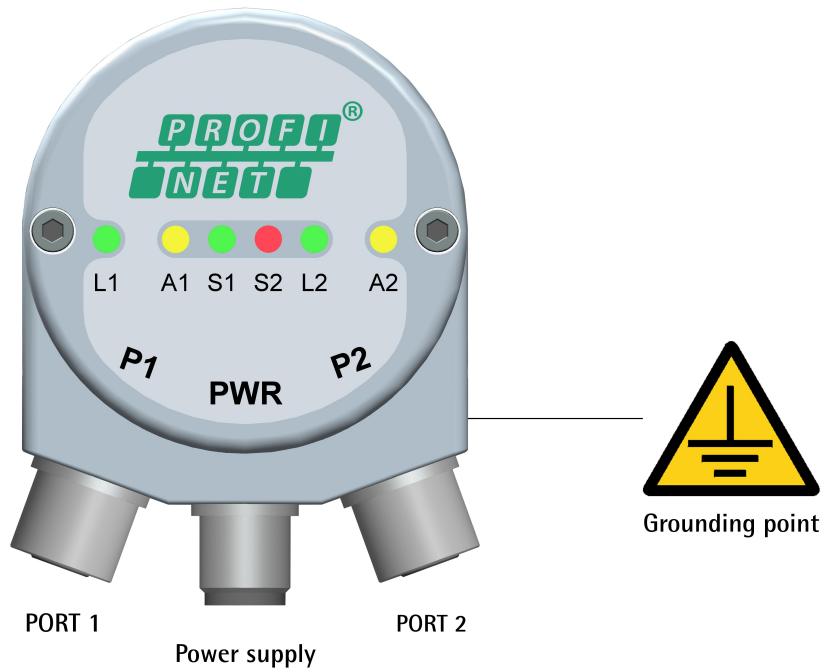
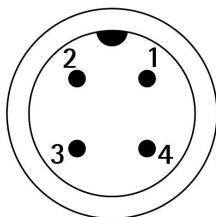

Figure 1 - Connectors and diagnostic LEDs

4.1 PWR Power supply connector (Figure 1)

M12 4-pin male connector with A coding is used for power supply.



| Description | Pin |
|---------------|-----|
| +10Vdc +30Vdc | 1 |
| n.c. | 2 |
| 0Vdc | 3 |
| n.c. | 4 |

4.2 P1 Port 1 and P2 Port 2 connectors (Figure 1)

Two M12 4-pin female connectors with D coding are used for Ethernet connection through port 1 and port 2.

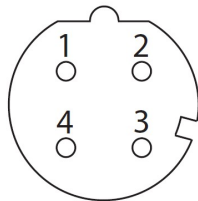

| Description | Pin |
|-------------|-----|
| Tx Data + | 1 |
| Rx Data + | 2 |
| Tx Data - | 3 |
| Rx Data - | 4 |

The ports are equal and interchangeable - if only one connection is required, either port can be used. The Ethernet interface supports 100 Mbit/s, full-duplex operation.

4.3 Network configuration: cables, hubs, switches - Recommendations

PROFINET is based on a 100 Mbps, full-duplex Ethernet network. Faster communication is also possible on all transmission sections (e.g., between switches, PC systems, or camera systems).

Using Ethernet several topologies of connection are supported by Profinet networks: line, tree, daisy-chain, star, ... Furthermore Profinet networks can be configured in almost any topology in the same structure.

The connection of PROFINET IO field devices occurs exclusively with switches as network components. Switches typically integrated in the field device are used for this (with 2 ports assigned). PROFINET-suitable switches must support "autonegotiation" (negotiating of transmission parameters) and "autocrossover" (autonomous crossing of send and receive lines).

Cables and connectors comply with the Profinet specifications. The cabling guide defines for all Conformance Classes a 2-pair cable according to IEC 61784-5- 3.

Standard Profinet cables commercially available can be used.

The maximum segment length for electrical data transmission with copper cables between two nodes (field devices or switches) is 100 m. The copper cables are designed uniformly in AWG 22. The installation guide defines different cable types, whose range has been optimally adapted to general requirements for industry. Sufficient system reserves allow industry-compatible installation with no limitation on transmission distance.

The PROFINET cables conform to the cable types used in industry:

- PROFINET Type A: Standard permanently routed cable, no movement after installation
- PROFINET Type B: Standard flexible cable, occasional movement or vibration
- PROFINET Type C: Special applications: for example, highly-flexible, constant movement (trailing cable or torsion)

For complete information please refer to IEC 61918, IEC 61784-5-13 and IEC 61076-2-101.

To increase noise immunity only S/FTP or SF/FTP cables must be used (CAT-5).

The maximum cable length (100 meters) predefined by Ethernet 100Base-TX must be compulsorily fulfilled.

Regarding wiring and EMC measures, the IEC 61918 and IEC 61784-5-13 must be considered.

For a complete list of the available cordsets and connection kits please refer to the product datasheet ("Accessories" list).

4.4 Ground connection (Figure 1)

To minimize noise connect properly the shield and/or the connector housing and/or the frame to ground. Connect properly the cable shield to ground on user's side. Lika's EC- pre-assembled cables are fitted with shield connection to the connector ring nut in order to allow grounding through the body of the device. Lika's E- connectors have a plastic gland, thus grounding is not possible. If metal connectors are used, connect the cable shield properly as recommended by the manufacturer. Anyway make sure that ground is not affected by noise. It is recommended to provide the ground connection as close as possible to the device. We suggest using the ground point provided in the cap (see Figure 1, use 1 TCEI M3 x 6 cylindrical head screw with 2 tooth lock washers).

4.5 MAC address and IP address

The unit can be identified in the network through the **MAC address** and the **IP address**. MAC address has to be intended as a permanent and globally unique identifier assigned to the unit for communication on the physical layer; while the IP address is the name of the unit in a network using the Internet protocol. MAC address is 6-byte long and cannot be modified. It consists of two parts, numbers are expressed in hexadecimal notation: the first three bytes are used to identify the manufacturer (OUI, namely Organizationally Unique Identifier), while the last three bytes are the specific identifier of the unit. The MAC address can be found on the label applied to the encoder. The IP address (and the subnet mask) must be assigned by the user to each interface of the unit to be connected in the network. For additional information on the MAC address refer to the "5.3 Mac address" section on page 35. For additional information on the IP address refer to the "5.4.7 Setting the IP address" section on page 53.

4.6 Diagnostic LEDs (Figure 1)

Six LEDs located in the cap of the encoder (see Figure 1) are meant to show visually the operating or fault status of the encoder and the Profinet interface. The meaning of each LED is explained in the following tables.

| LED | Description |
|-------------|---|
| L1 (green) | Link 1: link to another Ethernet component through port 1 |
| A1 (yellow) | Activity 1: incoming and outgoing traffic through port 1 |
| S1 (green) | Status 1: see table below |
| S2 (red) | Status 2: see table below |
| L2 (green) | Link 2: link to another Ethernet component through port 2 |
| A2 (yellow) | Activity 2: incoming and outgoing traffic through port 2 |

| S1 Status 1 green | S2 Status 2 red | Meaning | Cause |
|----------------------|--------------------|---|--|
| OFF | OFF | No power | <ul style="list-style-type: none"> • Unit switched off • Cable disconnected |
| ON | ON | No connection to another device Criteria: no data exchange | <ul style="list-style-type: none"> • Bus disconnected • Master not available or switched off |
| ON | Blinking at 1 Hz | Parametrization fault, no data exchange Criteria: data exchange is correct but the encoder does not switch to the data exchange mode | <ul style="list-style-type: none"> • Slave not configured yet or wrong configuration • A wrong address has been assigned to the unit • Actual configuration of the slave differs from the nominal configuration |
| OFF | ON | System failure | Diagnostic data exists, slave in data exchange mode |
| ON | OFF | Data exchange, the encoder is working properly | Correct operation |
| Blinking at 1 Hz | OFF | Flash memory upgrade process is active (see on page 149) | The user is upgrading the flash memory |
| OFF | Blinking at 1 Hz | Flash memory upgrade process failed (see on page 149) | <ul style="list-style-type: none"> • Cable disconnected • Power switched off • Internal error • Flash memory damaged • Upgrade process aborted before completion |

5 Getting started

5.1 Quick start information

The following instructions allow the operator to quickly and safely set up the device in a standard operational mode.

For complete and detailed information please read the mentioned pages thoroughly.

- Mechanically install the device, see on page 24 ff;
- execute the electrical and network connections, see on page 29 ff;
- switch on the +10Vdc +30Vdc power supply;
- install the GSDML file, see on page 37 ff;
- insert the Lika module and type of telegram in the PROFINET-IO system, see on page 40 ff;
- set the device name, see on page 43 ff;
- if required¹, set the IP address and the subnet mask to the node see on page 53 ff; the default address set by Lika is **0.0.0.0**;
- to set the parameters, enter the **Parameter Access Point** slot 1.1, see on page 57 ff; in this page it is possible, for example, to set the singleturn resolution or the total resolution, to enable the scaling function or to change the counting direction; after entering new values, you must download the parameters to the device; the complete list of the default parameters is available on page 160;
- to enable the scaling function, change the counting direction and execute the preset, the **Class 4 functionality** parameter must be enabled (= "1"), see on page 91.

5.1.1 Setting the resolution and the scaling function

- If you want to use the physical resolution of the encoder, please check that the **Scaling function control** parameter is disabled (= "0"), see on page 92; this parameter is active only if the **Class 4 functionality** parameter is enabled (= "1"), see on page 91;
- on the contrary, if you need a custom resolution, you must enable the scaling function by setting the **Scaling function control** parameter to = "1" first and then set the required resolution values:

¹ Actually the setting of the IP address is not mandatory. If the **Assign IP address via IO controller** check box in the **Properties** dialog window is not selected (see on page 53), the IP address stored in the encoder memory is used (this operation can be accomplished by using for instance the PST Primary Setup Tool from Siemens; please note that the encoder address set by default is 0.0.0.0, in compliance with Profinet specifications). Otherwise, if the check box is selected, the controller automatically suggests an IP address to the device (it can be changed according to needs). For more information please refer to page 53.

- open the **Properties – Parameter Access Point** dialog window and set the singleturn resolution next to the **Measuring units / Revolution** parameter, see on page 57 and on page 94;
- open the **Properties – Parameter Access Point** dialog window and set the total resolution next to the **Total measuring range** parameter, see on page 57 and on page 94.

5.1.2 Reading the position

- To read the value of the absolute position use the variable tables (for instance, if the Standard Telegram 83 is installed, use the **Telegram 0x53** table available in the project example provided by Lika, see on page 137 and the **G1_XIST1** parameter on page 75).

5.1.3 Setting and executing the preset

- To set and execute the preset proceed as follows:
 - check that the **Control by PLC** bit 10 of the **STW2_ENC** control word is ="1", see on page 77;
 - check that the **Class 4 functionality** parameter is enabled (="1"), see on page 91;
 - check that the **G1_XIST1 preset control** parameter is enabled (="0"), see on page 91;
 - set the preset value by means of an acyclic data exchange: it is possible to use the **P65000-Preset** variable table available in the project example provided by Lika (see on page 136 and the **P65000 – Preset value** parameter on page 87); or enter the **Change the preset value** page in the web server, see on page 156;
 - execute the preset by forcing high the **Request set/shift of home position** bit 12 in the **G1_STW** control word, see on page 79;
 - the encoder replies by forcing high the **Set/shift of home position executed** bit 12 in the **G1_ZSW** status word, see on page 82;
 - the Master must set back to 0 the **Request set/shift of home position** bit 12 in the **G1_STW** control word, see on page 79;
 - the **Set/shift of home position executed** bit 12 in the **G1_ZSW** status word is set back to 0, see on page 82; see the diagram on page 140.

To save the set parameters, please use the **P971 – Transfer to non volatile memory** PROFdrive parameter (="1"), see on page 85.

5.2 Configuring the encoder with Siemens SIMATIC STEP 7

In this manual some screenshots are shown to explain how to install and configure the encoder in a supervisor. In the specific example the development environment is STEP 7 V5.5 + SP1 with SIEMENS PLC CPU 315-2 PN / DP. Therefore, the installation of the GSDML file, the assignment of the IP address and the device name, the configuration of the encoder in the network, topology, diagnostics, etc. will always refer to the aforementioned development tools. If you need to install the encoder using a different configuration tool, please read and follow carefully the instructions given in the documentation provided by the manufacturer.



Lika Electronic Profinet encoder documentation is complete with an **example project** provided free of charge. This program is designed to make your own project planning, programming, communication and diagnostics with the STEP 7 V5.5 + SP1 development environment user-friendly and reliable. You can find it in the **Lika Step 7 Profinet example project.zip** compressed file contained in the **SW Hx58x PT.zip** file.



WARNING

If the encoder is used as a **TO Technology Object**, please refer to the "5.7 TO Technology Objects" section on page 64.

5.3 Mac address

The MAC address is an identifier unique worldwide. The MAC-ID consists of two parts: the first 3 bytes are the manufacturer ID and are provided by IEE standard authority; the last three bytes represent a consecutive number of the manufacturer.



NOTE

The MAC address is always printed on the encoder label for commissioning purposes.

The MAC address has the following structure:

| Bit value 47 ... 24 | | | Bit value 23 ... 0 | | |
|---------------------|----|----|--------------------|---|---|
| 10 | B9 | FE | X | X | X |
| Company code (OUI) | | | Consecutive number | | |

5.4 Encoder installation under STEP 7 environment

5.4.1 Description of the GSDML file

The functionality of a PROFINET IO device is always described in a GSDML file. This file contains all data that are relevant for engineering as well as for data exchange with the IO device.

PROFINET IO devices can be described using XML-based GSD. The description language of the GSD file, i.e. GSDML (General Station Description Markup Language) is based on international standards. As the name suggests, the GSD file is a language-independent XML file (Extensible Markup Language).

Profinet encoders from Lika Electronic are supplied with their own GSDML file **GSDML-V2.25-LIKA-0239-ROTACOD-XXXXXXXX.XML** where XXXXXXXX is the release date of the file in a 8-digit format encompassing information about year (4 digits), month (2 digits) and day (2 digits): **20131024** is the first GSDML file released by Lika Electronic for Profinet encoders. See the enclosed documentation or click www.lika.biz > **ROTARY ENCODERS** > **ABSOLUTE ENCODERS** > **PROFINET** to get the GSDML file.



WARNING

Please always comply with the specifications indicated in the following table:

| GSDML file version | Encoder HW version | Encoder SW version | User's guide version |
|------------------------------|--------------------|--|---|
| From release 20131024 to ... | 1 | 1.0.1 1.0.2 1.0.3 1.0.4, 1.0.5 1.0.5 | 1.0, 1.1 1.2 1.3 1.4 1.5, 1.6 |

5.4.2 Installing the GSDML file

In the menu bar of the **HW Config** window, press **Options** and then **Install GSD File ...** command.

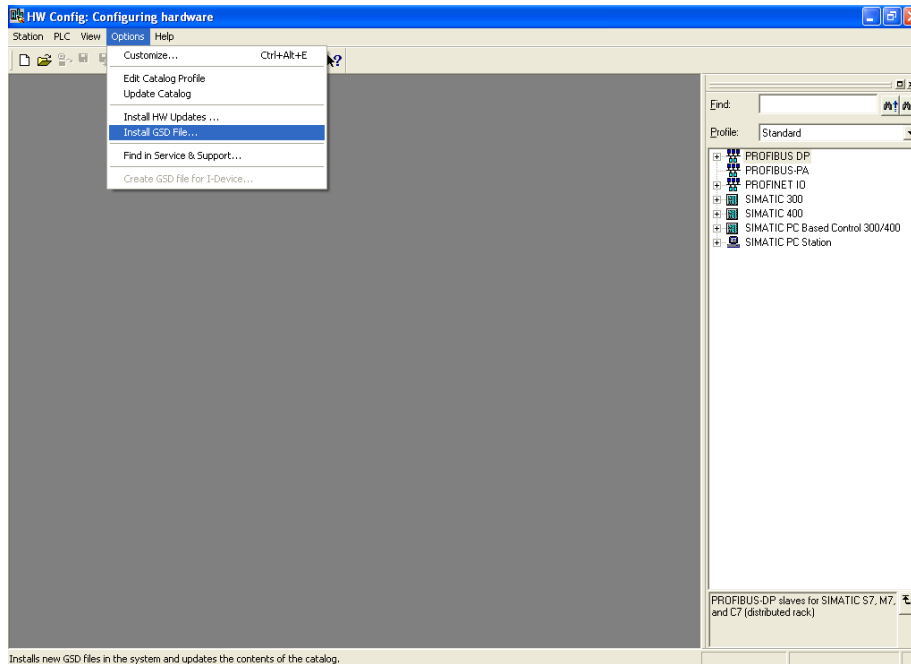

Figure 2 - Installing the GSDML file

The **Install GSD Files** dialog box will appear. Press the **Browse ...** button to choose the folder where the GSDML file is located. Please make sure that the bitmap file representing the encoder is located in the same folder as the GSDML file. Select the file and press the **Install** button to install it.

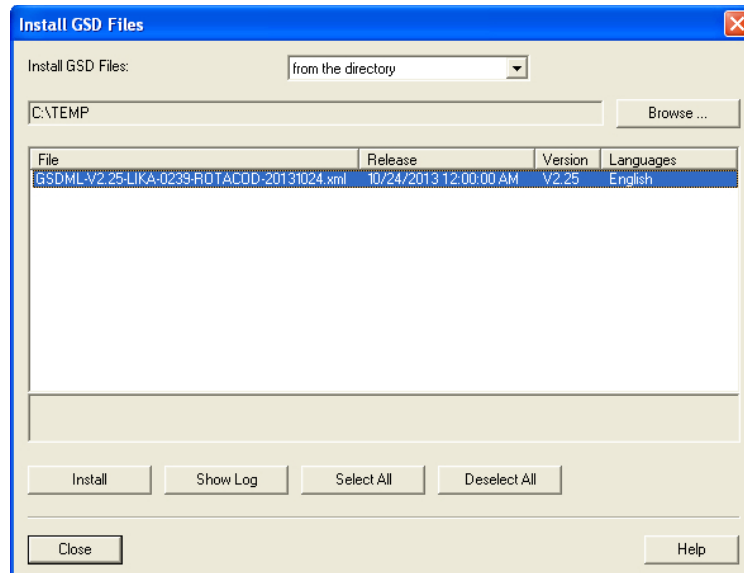

Figure 3 - Selecting the GSDML file

As soon as the operation is carried out, a confirmation dialog box will appear on the screen.

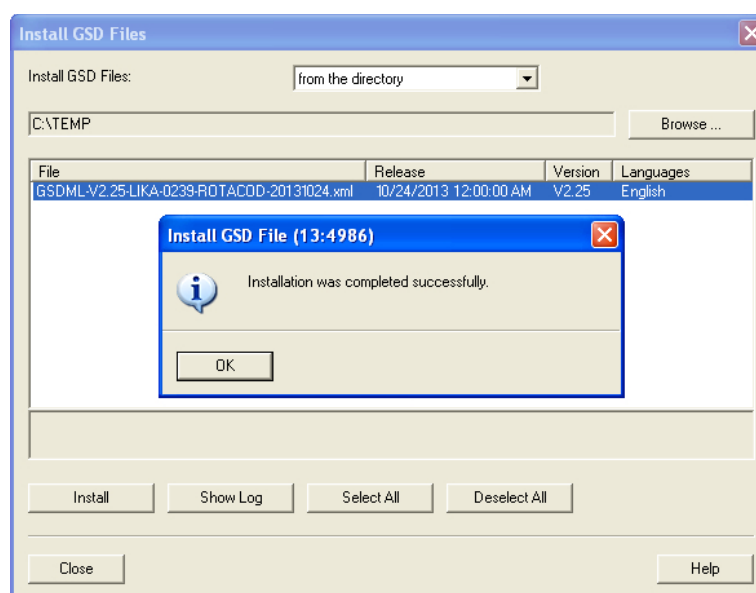

Figure 4 - GSDML file installation

Now scroll through the directory tree in the left pane of the **HW Config** window and select the path **Catalog \ PROFINET IO \ Additional Field Devices \ Encoders**: the **LIKA ROTACOD** family can be found inside the folder. The installation modules are contained in the directories MULTITURN (for multiturn version encoders) and SINGLETURN (for singleturn version encoders).

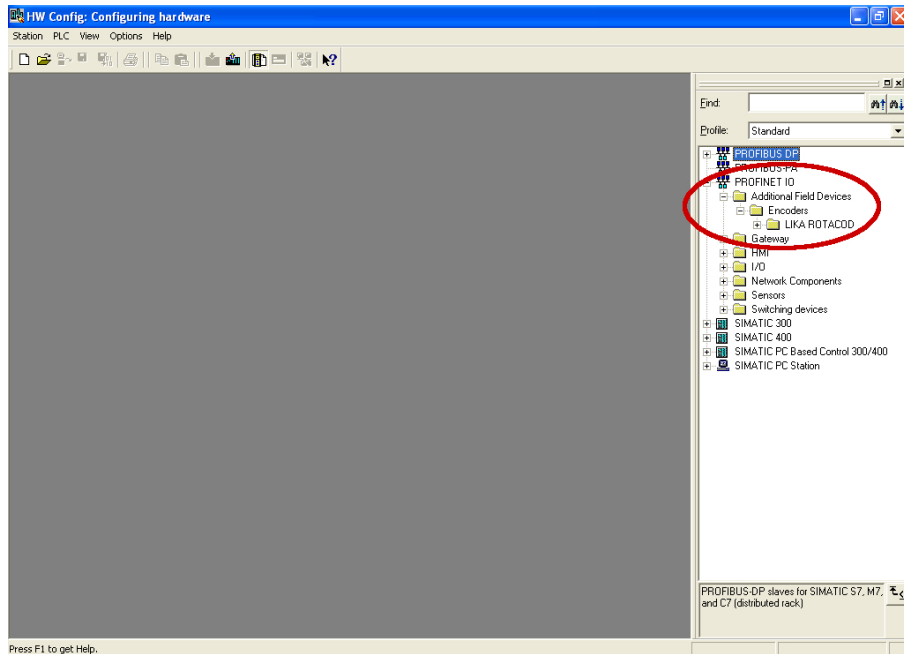

Figure 5 - Scrolling through Profinet families and categories

5.4.3 Inserting the module in the Profinet-IO system

Now we need to install the module of the desired model. For instance, we want to configure the HMx16/16384PT model.

In the right pane open the LIKA ROTACOD directory and then choose the MULTITURN directory. Drag the required module LIKA HMx16/16384PT to the window on the left and drop it on the PROFINET-IO system.

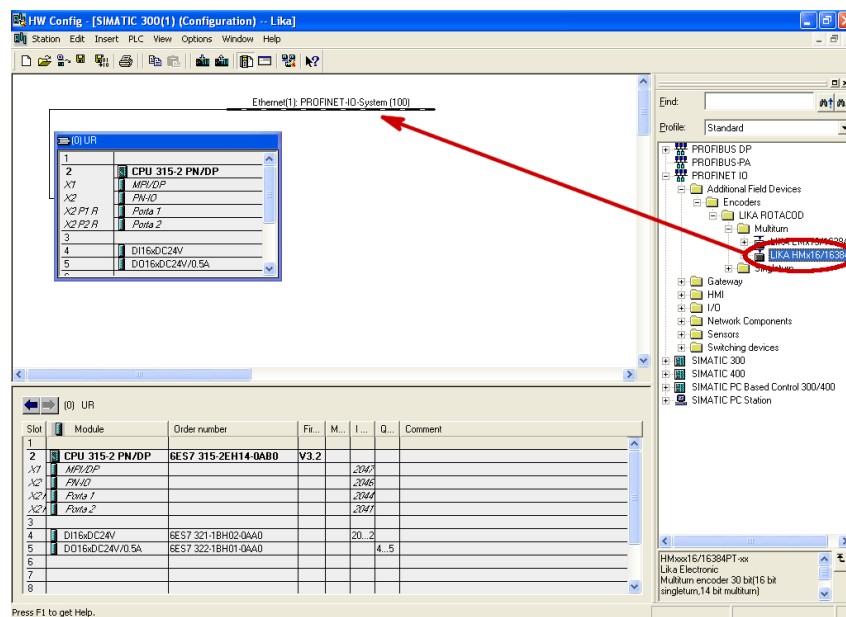

Figure 6 - Inserting a module in the Profinet-IO system

The inserted module will appear as shown in the following screenshot:

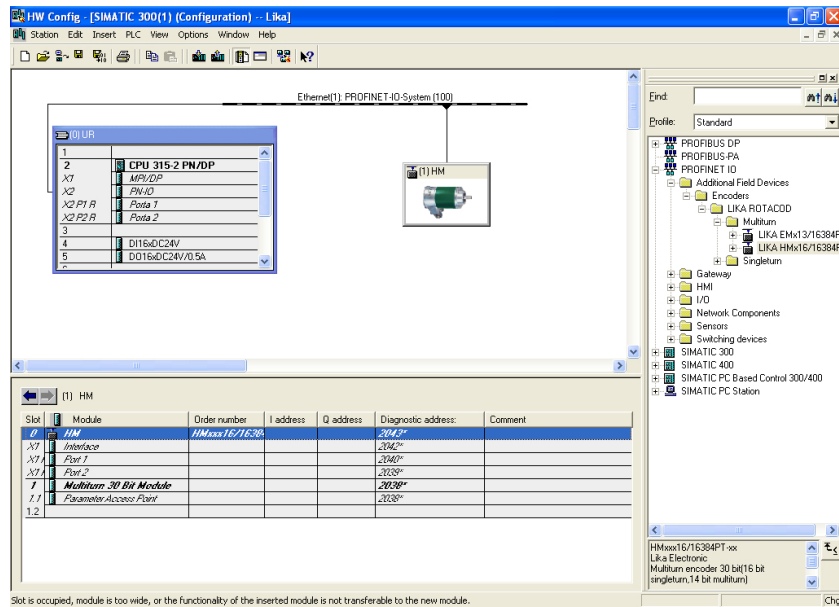

Figure 7 - Inserted module

Now we need to choose the data length and the type of data that should be sent to and from the IO controller, thus we need to install a Standard Telegram. Four types of telegrams with different characteristics are available: Standard Telegram 81, Standard Telegram 82, Standard Telegram 83 and Standard Telegram 84. For detailed information on the Standard Telegrams refer to the section "7.1 Telegrams" on page 71.

For instance we need to install the Standard Telegram 83. To do this select the desired Telegram available for the LIKA HMx16/16384PT module (it can be found under LIKA HMx16/16384PT\MULTITURN 30 bit MODULE) and drag and drop it onto the variables table in the bottom left, as shown in the Figure.

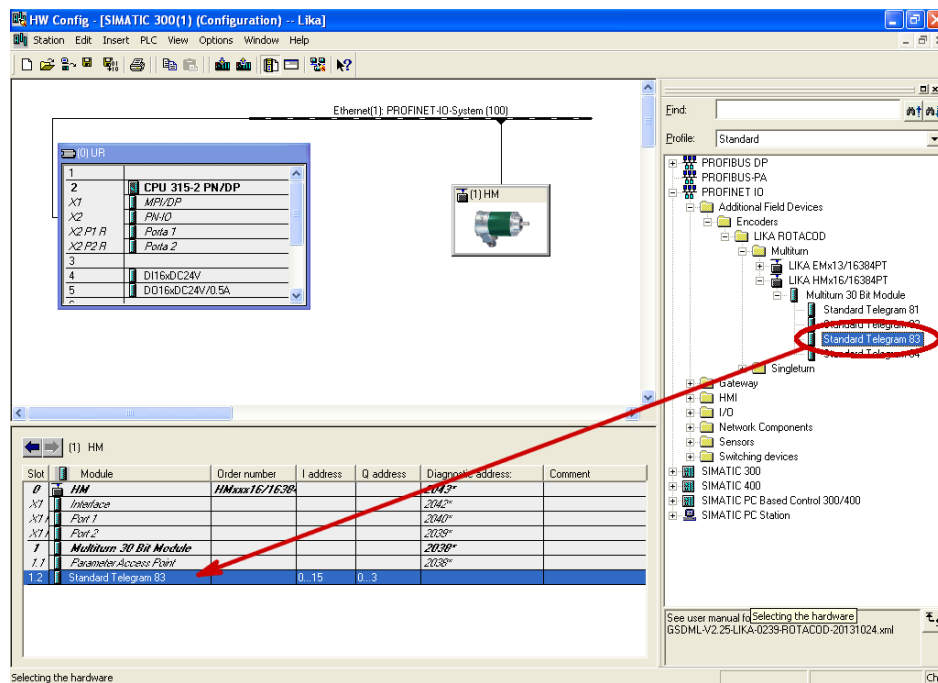

Figure 8 - Adding the Standard Telegram

5.4.4 Device name and IP address at delivery

In a Profinet network it is mandatory that each IO device is provided with its own Device name and IP address. By default, before delivery the device name of the encoder is set to a **blank string** and its IP address is set to **0.0.0.0**. When the system boots up, the IO controller assigns the IP address to the IO device. Please make sure that the **Assign IP address via IO controller** check box in the **Properties** dialog box is selected if the IP address has to be assigned to the encoder via the IO controller. Anyway the assignment of the IP Address can be disabled by deselecting the **Assign IP address via IO controller** check box. In this case the IP address set in the IO device is used (the IP address is uploaded from the internal memory). You are required to enter the Device name first and then the IP address.

5.4.5 Setting the device name

Before the PROFINET IO controller can address a PROFINET IO device, a name has to be assigned to the PROFINET IO device. PROFINET uses this method because names are easier to use and recall than complex IP addresses. Devices on an Ethernet subnet must have unique names.



NOTE

An IO Device does not have a device name when delivered. By default, the device name of Lika's Profinet encoders is set to a **blank string**.

The device names must satisfy DNS (Domain Name System) conventions:

- Names are limited to a total of 127 characters (letters, numbers, dashes or dots).
- Any component part (that is, a character string between two dots) of the device name may only be up to 63 characters long.
- Names cannot contain any special character such as umlauts, parentheses, underscores, forward or backward slashes, empty spaces, etc. The dash is the only special character allowed.
- Names must neither start nor end with the minus "-" sign.

There are a couple of ways to assign the device name to the encoder. The steps are described in the following tables.

Steps for system start-up

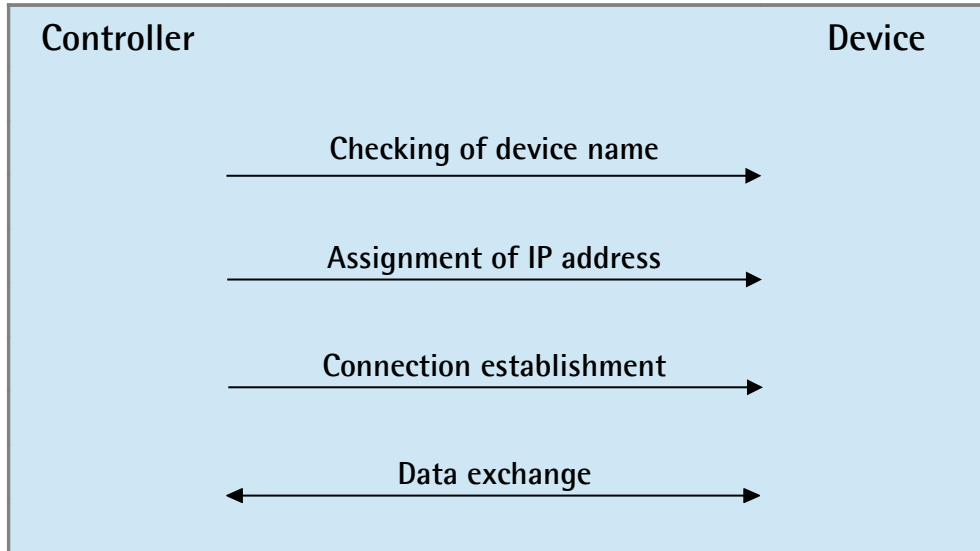

Start-up response

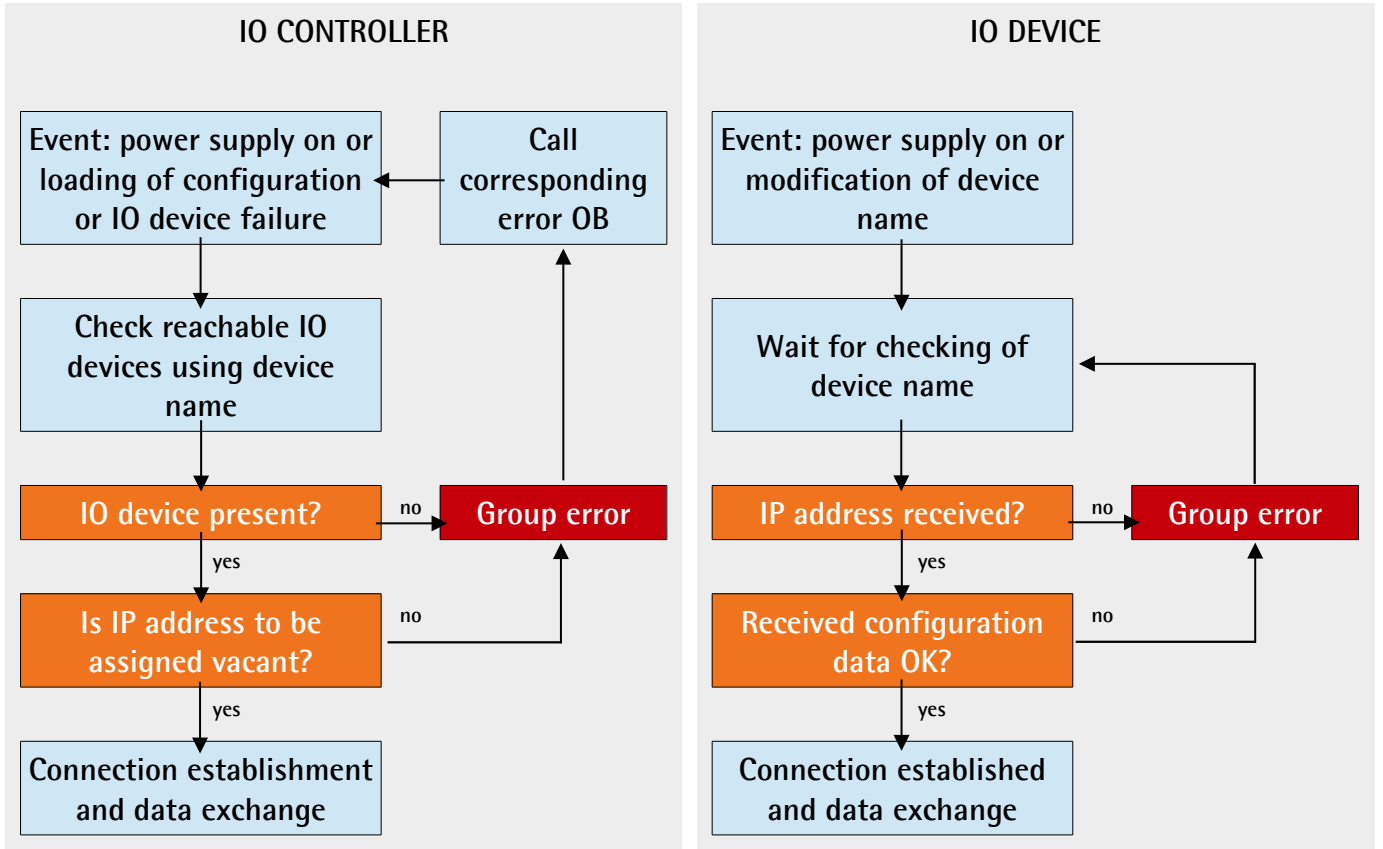

Mode 1

Enter the **Properties** dialog box by double clicking the encoder icon in the **HW Config** window and set the device name in the **Device name** field. Check that the **Assign IP address via IO controller** check box is selected if you want the IP address being assigned by the IO controller; otherwise deselect it if you want it to be uploaded from the internal memory of the IO device.

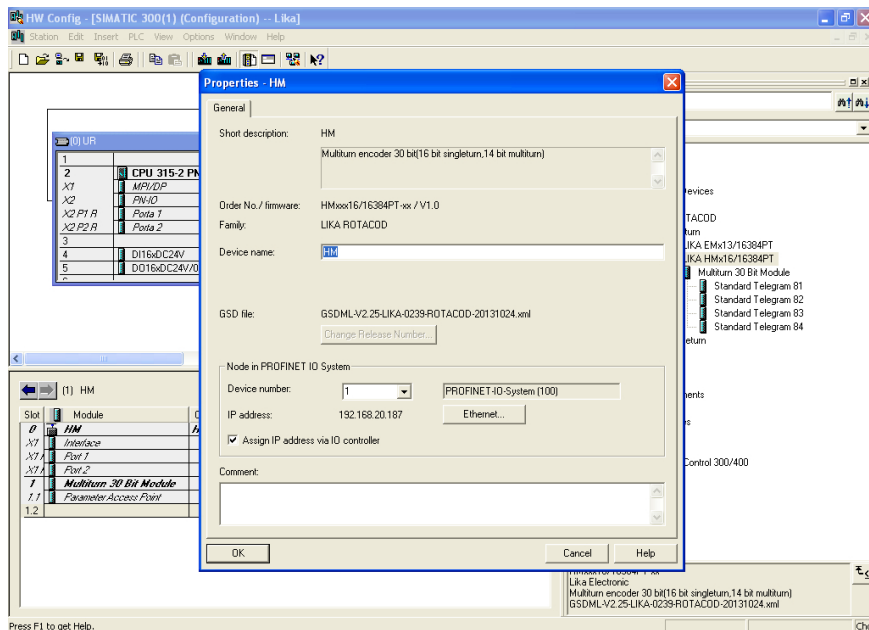

Figure 9 – Assigning the device name



NOTE

The device name default setting is the name from the GSD file. With integral Profinet interfaces, the device name is derived from the short description. If several devices of the same type are arranged in the same Profinet IO system, Step 7 automatically supplements the name from the GSD file with a serial number. The second device is assigned the extension "-1", the third device the extension "-2", etc.

Press the **Ethernet...** button in the **Node in PROFINET IO system** group if you want to assign an IP address different from the one suggested by the system.

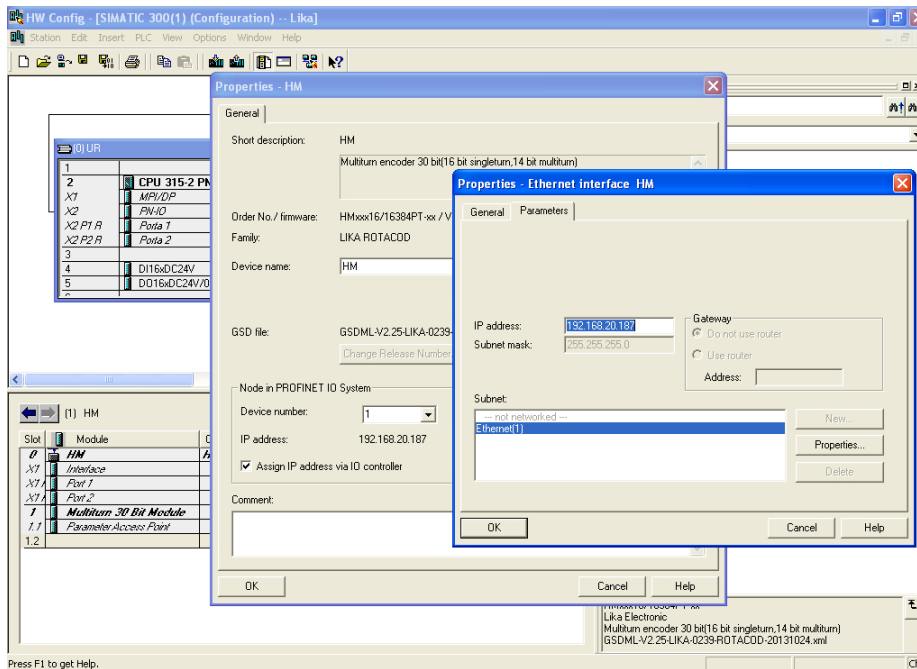

Figure 10 – Assigning the IP address

Download data to the PLC pressing the **Download** button in the Toolbar.

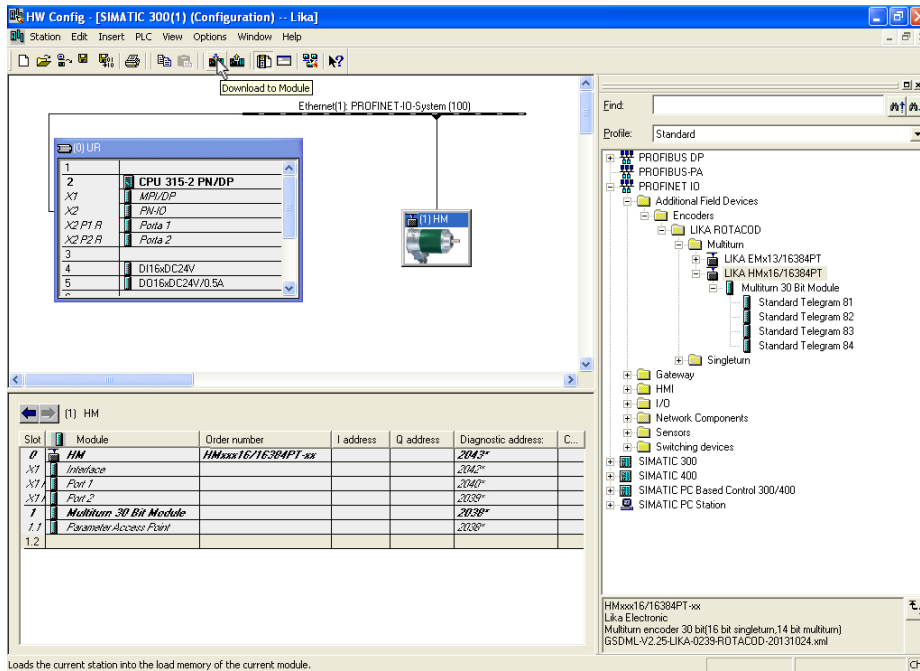

Figure 11 - Downloading data to the PLC

Now press **PLC, Ethernet** and then **Assign Device Name...** command in the menu bar of the **HW Config** window.

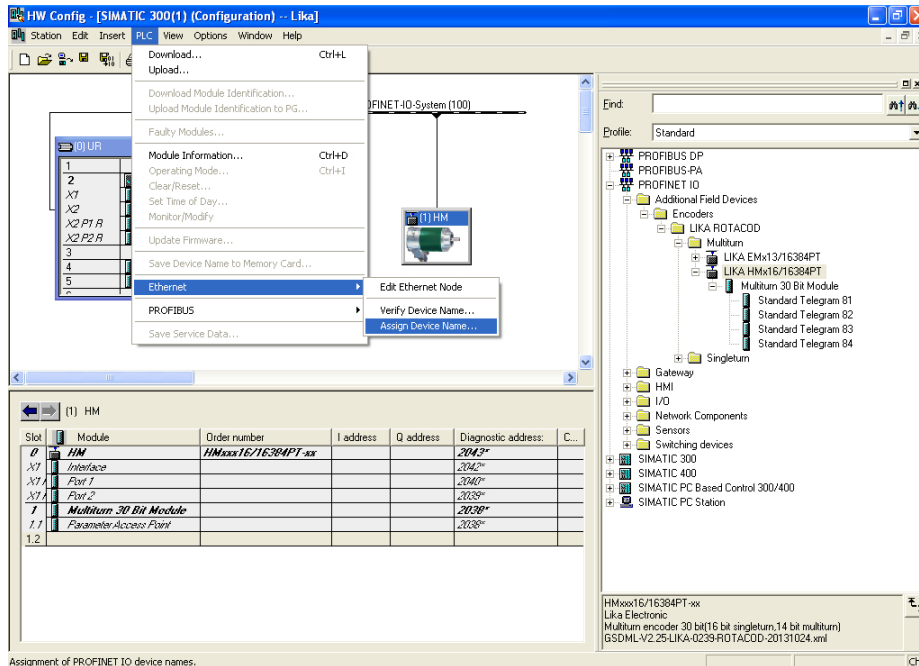

Figure 12 - Assigning the device name

Choose the device that needs the name to be changed in the **Device name** drop box and then press the **Assign name** button.

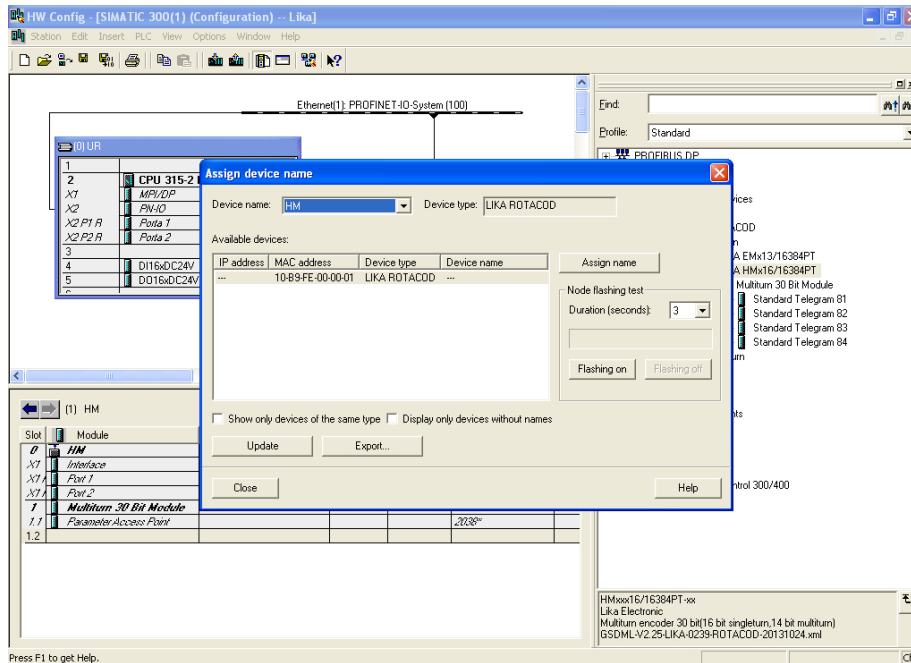

Figure 13 – Confirming the device name

Mode 2

As explained for the Mode 1, first of all enter the **Properties** dialog box by double clicking the encoder icon in the **HW Config** window and set the device name in the **Device name** field. Then press **PLC**, **Ethernet** and then **Edit Ethernet node** command in the menu bar of the **HW Config** window. Press the **Browse...** button to find all the nodes connected to the network. Select the IO device you want to assign the Device name to. The MAC address of the encoder is written on the encoder label. In the **Assign device name** group below in the dialog box, enter the desired name in the **Device name** field. Press the **Assign Name** button to confirm.

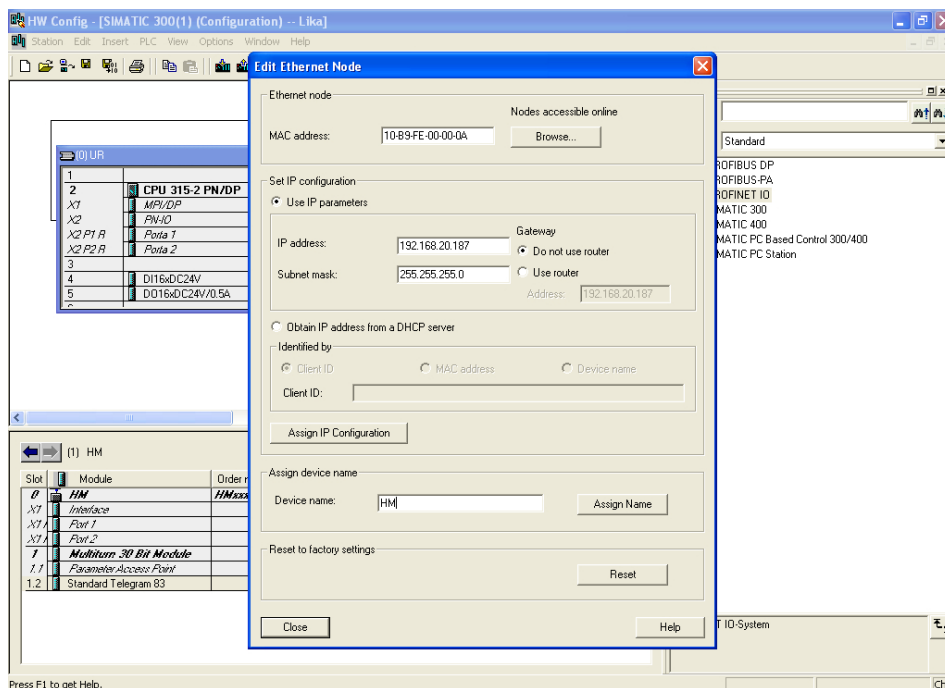

Figure 14 - Edit Ethernet Node dialog box



NOTE

The device name default setting is the name from the GSD file. With integral Profinet interfaces, the device name is derived from the short description. If several devices of the same type are arranged in the same Profinet IO system, Step 7 automatically supplements the name from the GSD file with a serial number. The second device is assigned the extension "-1", the third device the extension "-2", etc.

The following confirmation message will appear on the screen.

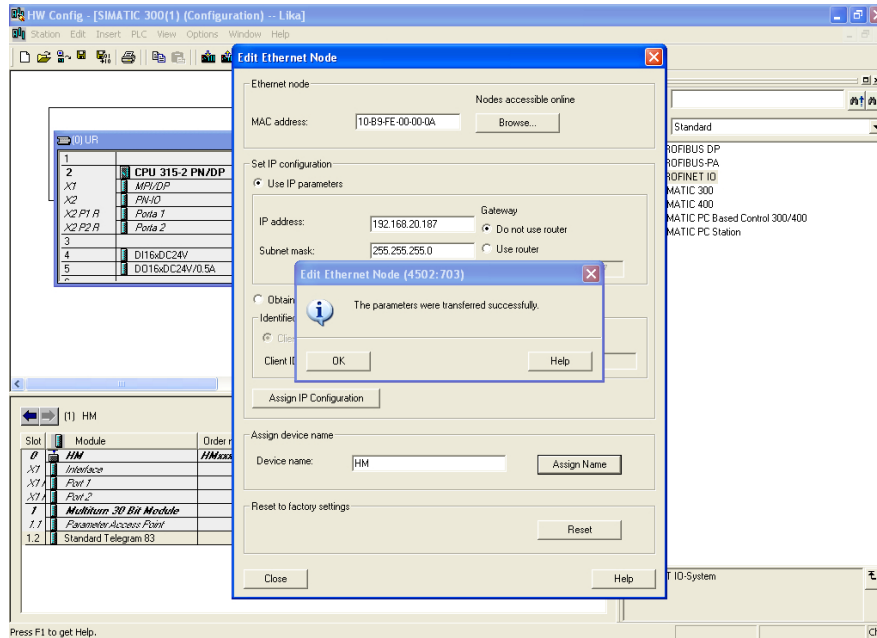

Figure 15 – Edit Ethernet Node confirmation

After completing the operation, we can easily check the entered Device Name. To do this press again the **Browse...** button in the **Edit Ethernet node** page to find all the nodes connected to the network. Check that the encoder is listed properly in the page.

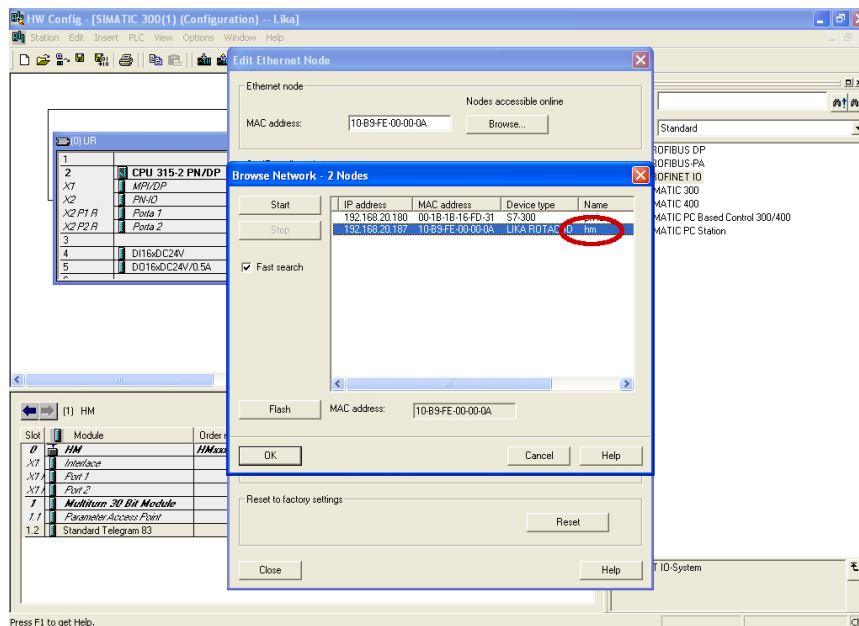

Figure 16 – Browsing the network

5.4.6 Checking the device name

After completing the operation, we recommend the Device Name to be checked. To do this press **PLC, Ethernet** and then **Verify Device Name...** command in the menu bar of the **HW Config** window.

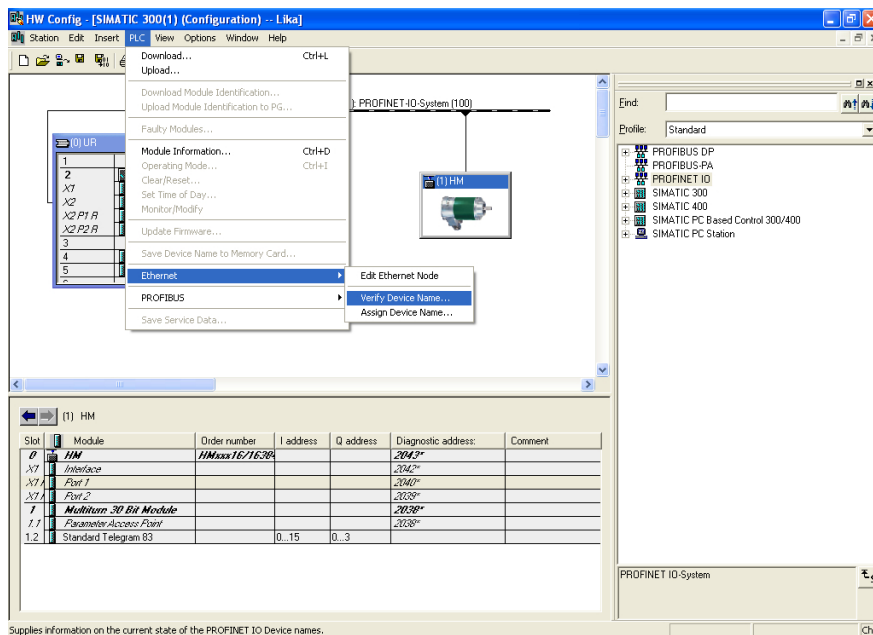

Figure 17 - Verifying device name

In the **Verify Device Name** dialog box, check that the encoder is listed properly with correct Device name and status.

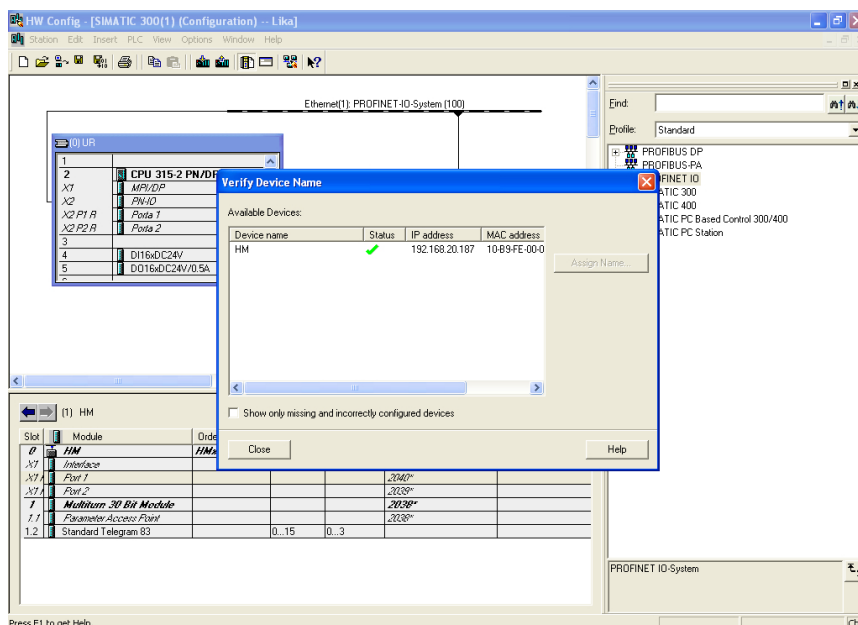

Figure 18 - Verifying device name

5.4.7 Setting the IP address

To help with configuration you are required only once to assign an IP address. When configuring the PROFINET IO controller in the **HW Config** window, STEP 7 opens a dialog for selecting the IP address and the Ethernet subnetwork.

When the system boots up, the IO controller assigns the IP address to the IO device. Please make sure that the **Assign IP address via IO controller** check box in the **Properties** dialog box is selected if the IP address has to be assigned to the encoder via the IO controller. Anyway the assignment of the IP Address can be disabled by deselecting the **Assign IP address via IO controller** check box. In this case the IP address set in the IO device is used (the IP address is uploaded from the internal memory). By default, before delivery the IP address of the encoder is set to **0.0.0.0**.

After having set the Device name, you can set the IP Address. To set the IP address first enter the **Properties** dialog box by double clicking the encoder icon in the **HW Config** window. Check that the **Assign IP address via IO controller** check box is selected if you want the IP address being assigned by the IO controller; otherwise deselect it if you want it to be uploaded from the internal memory of the IO device. Press the **Ethernet...** button in the **Node in PROFINET IO system** group if you want to assign an IP address different from the one suggested by the system. Press the **OK** button to confirm. Download data to the PLC pressing the **Download** button in the Toolbar.

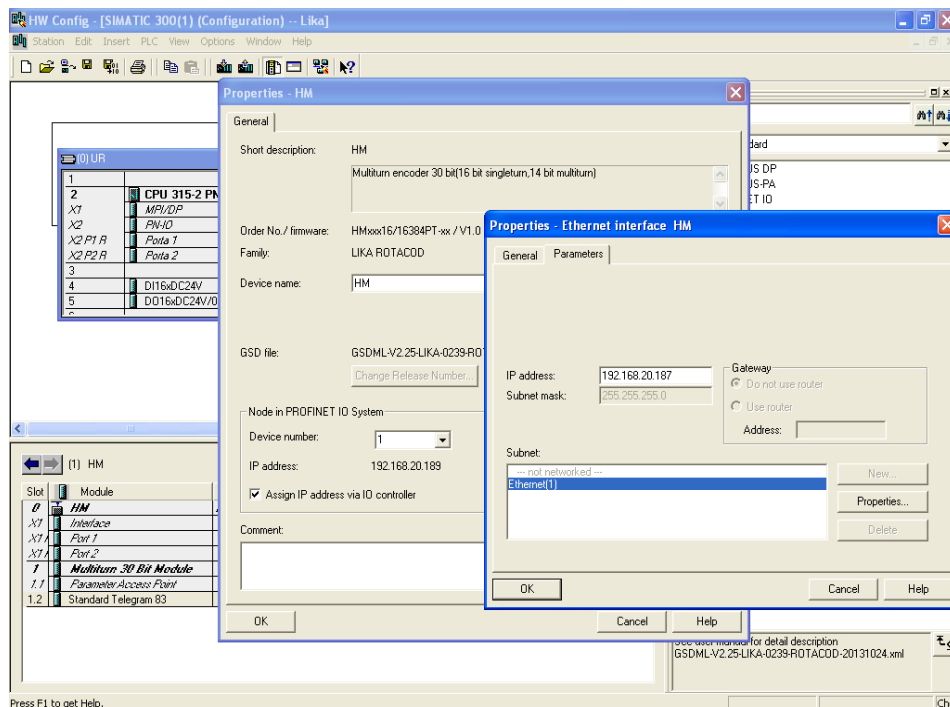

Figure 19 - Setting the IP address

If you want to change both the IP address and the subnet mask you can also proceed as follows.

Press **PLC, Ethernet** and then **Edit Ethernet node** command in the menu bar of the **HW Config** window. Press the **Browse...** button to find all the nodes connected to the network. Select the IO device you want to assign the IP address to. The MAC address of the encoder is written on the encoder label. Select the LIKA ROTACOD device type and then press the **OK** button to confirm.

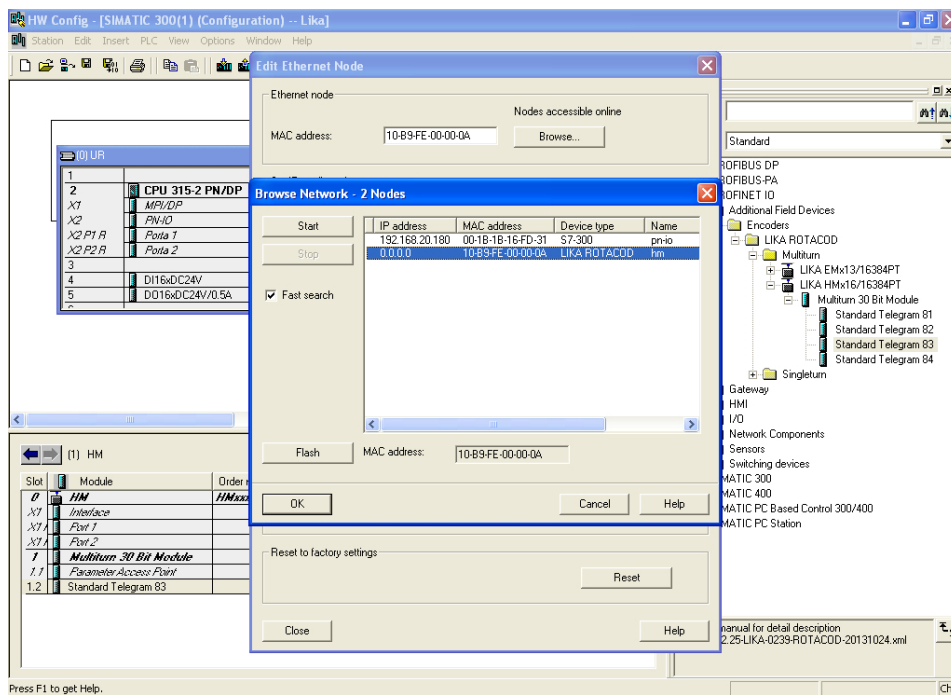

Figure 20 - Browsing the network

In the **Set IP configuration** group, enter the required IP address in the **IP address** field; enter the required subnet mask in the **Subnet mask** field below. Press the **Assign IP configuration** button to confirm.

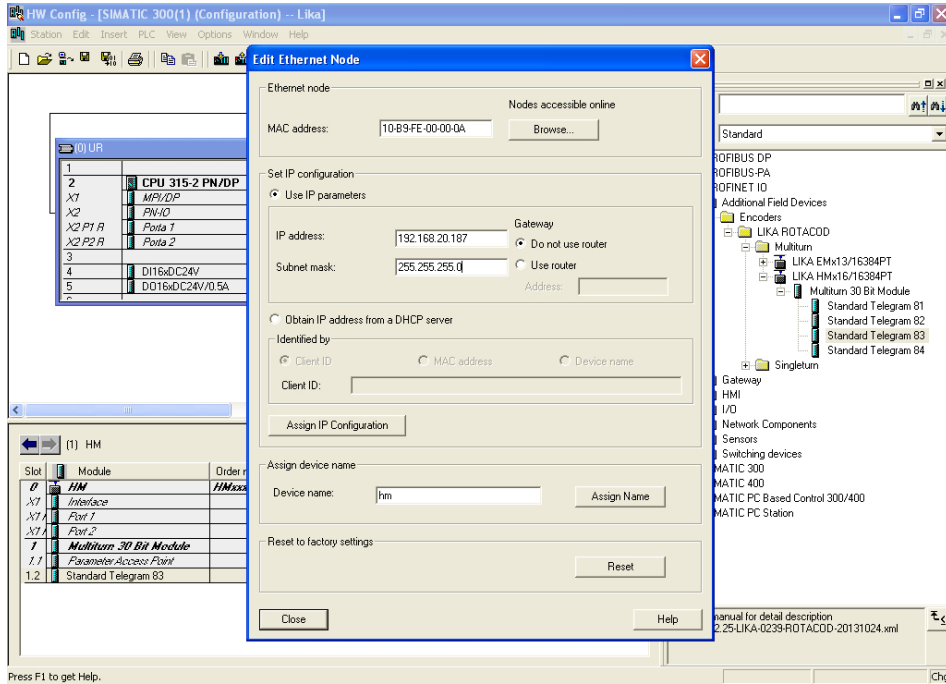

Figure 21 - Assigning IP configuration

The following confirmation message will appear on the screen.

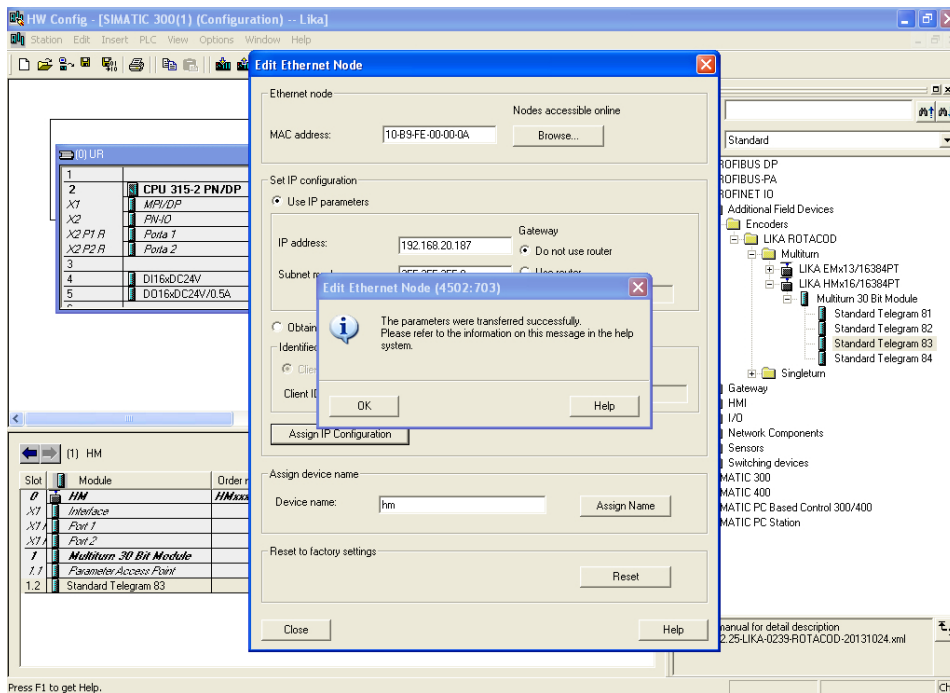

Figure 22 - Edit Ethernet Node confirmation

Now press the **OK** button to close the message and then press again the **Browse...** button in the **Edit Ethernet node** page to find all the nodes connected to the network and check whether the encoder is listed properly in the page.

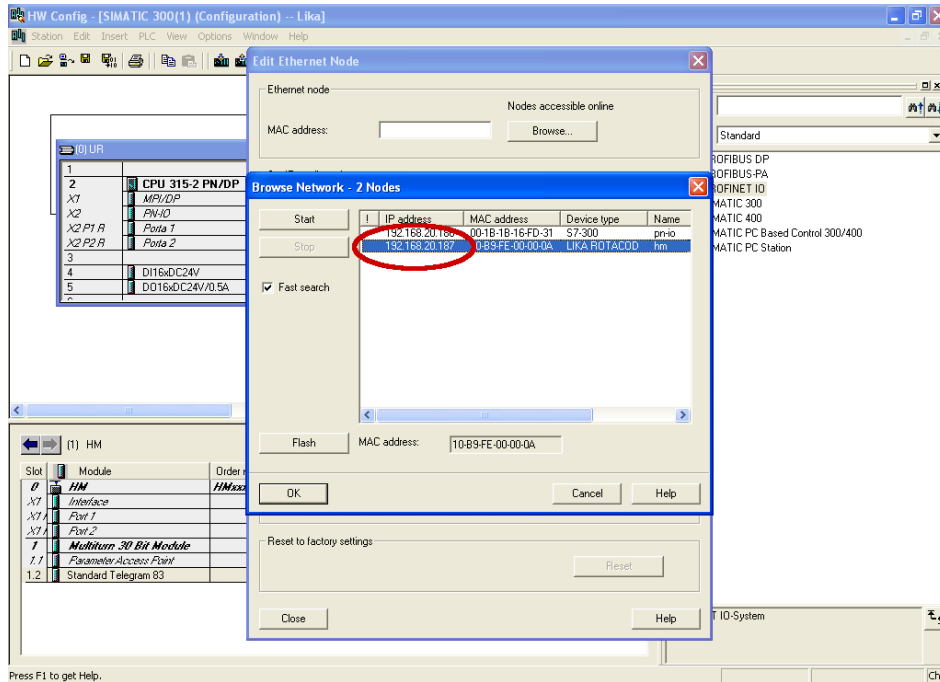

Figure 23 - Browsing the network

The new IP address has been assigned.

5.5 Setting the parameters: Parameter Access Point

Double click the **Parameter Access Point** slot 1.1 of the module to open the dialog box where the encoder parameters are listed.

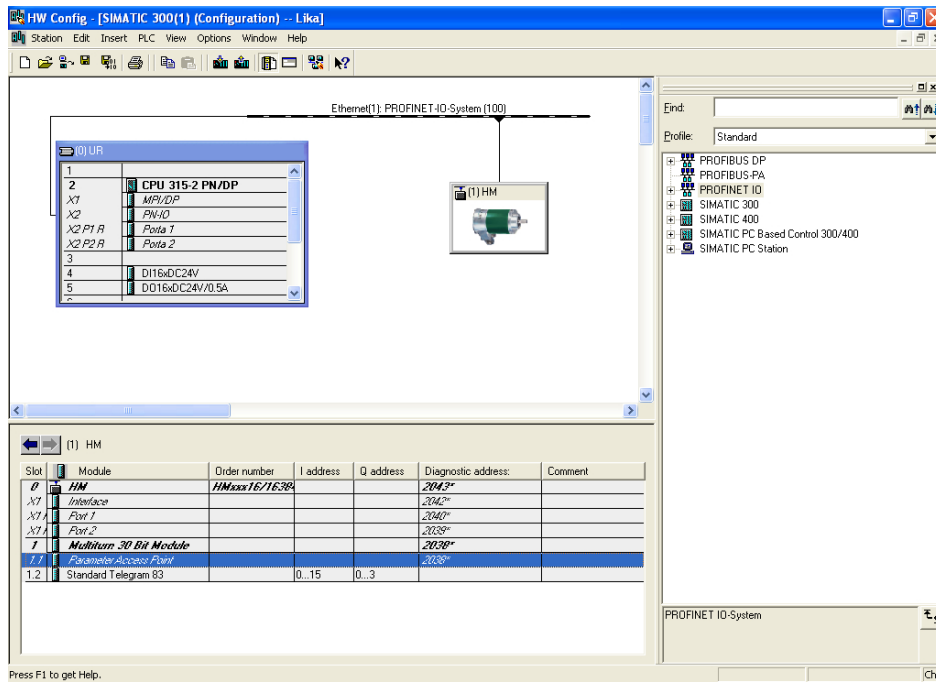

Figure 24 - Entering the Parameter Access Point dialog box

The **Properties – Parameter Access Point** property sheet will appear. Enter the **Parameters** tabbed page to display the complete list of the parameters available for the Profinet encoder.

The encoder specific parameters implemented by the manufacturer are shown in the table. The parameters data is transferred to the encoder using 0xBF00 data record at each system boot up.

To set the parameter data, select the value in the drop-down list next to each parameter in the column **Value**.

For detailed information on the implemented parameters, please refer to the "9.4 Index 0xBF00 : user parameter data" section on page 90.

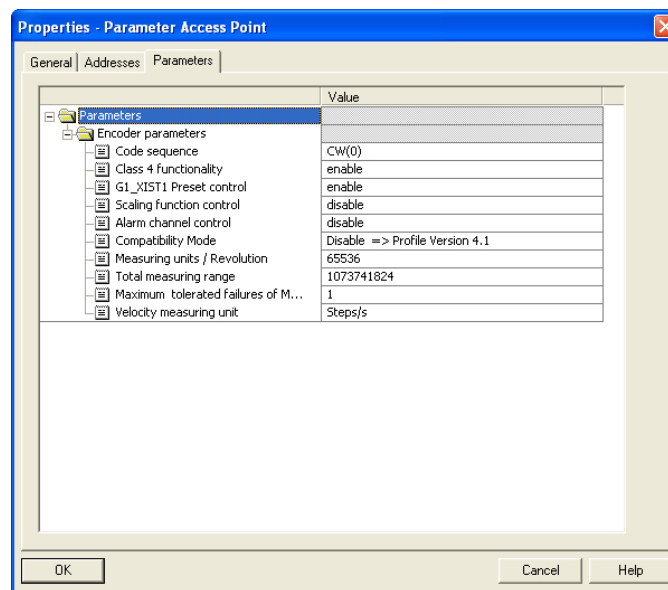

Figure 25 – Parameter Access Point properties

After having changed any parameter values, you need to download data to the PLC pressing the **Download** button in the Toolbar.

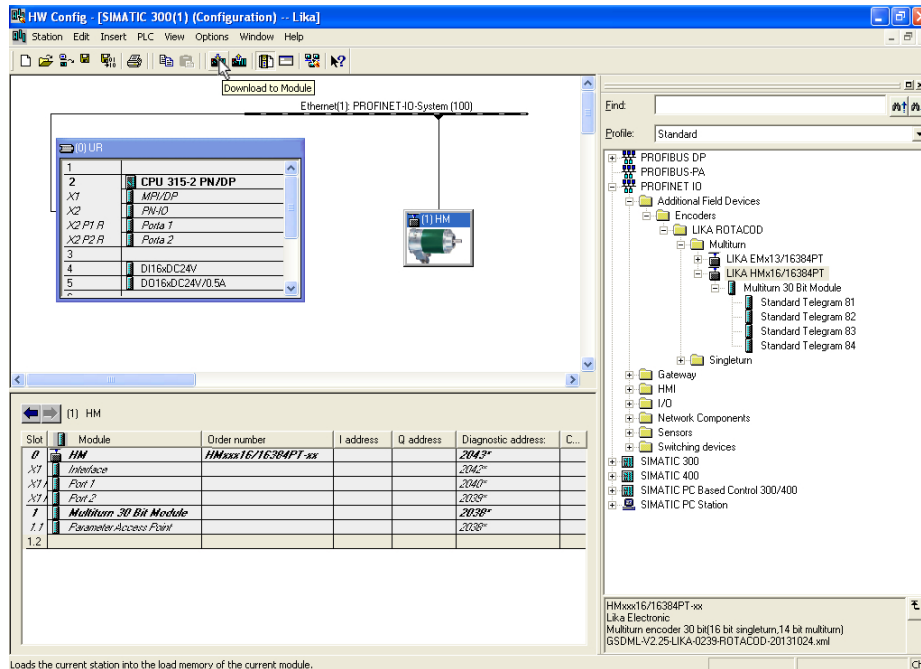

Figure 26 - Downloading data to the PLC

Please note that a description / help message appears on the display when you move the cursor over the items listed on the left.

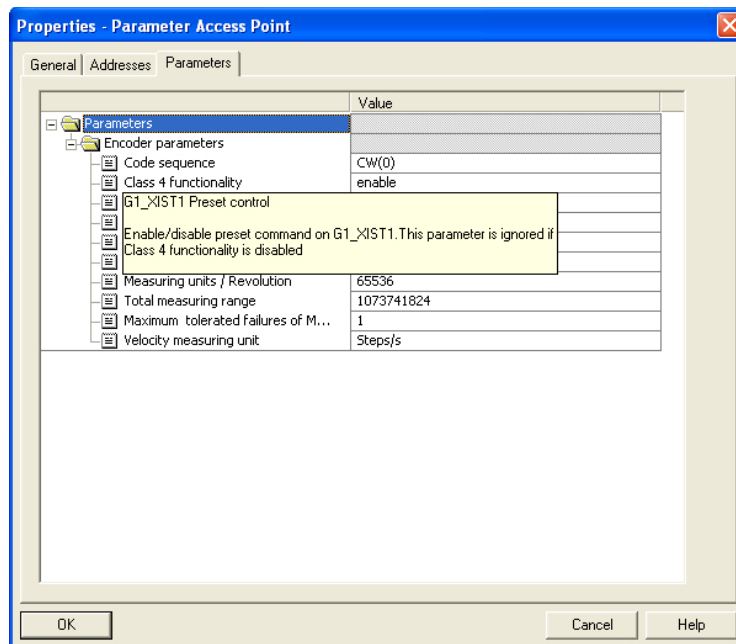

Figure 27 - Parameter Access Point help messages

5.6 Resetting the parameters to default factory values

Default values are provided to each parameter of the device and are preset at the factory by Lika Electronic engineers. The first time you install the encoder, it will operate using the default values. They allow the operator to run the IO device for standard and safe operation. They are plainly not optimized for specific application yet they provide maximum performance for most systems. To suit the specific application requirements it may be advisable and even necessary to enter new parameters instead of the factory default settings. There could be exceptional circumstances where it would be necessary for you to restore the default values of the settable parameters. When this is the case, you have to use the **Reset** command.



NOTE

When you restore the default values, please always consider that:

- the encoder parameters will be restored to the default values;
- the encoder offset will be reset;
- the Device Name will be lost and replaced with a blank string;
- the IP address will be set to 0.0.0.0;
- the parameters associated with the IP range will be set to 0.



WARNING

The execution of this command causes all the values which have been set previously next to each parameter to be overwritten!



NOTE

The complete list of machine data and relevant default parameters preset by Lika Electronic engineers is available on page 160.

When you need to restore the default values proceed as follows. Press **PLC**, **Ethernet** and then **Edit Ethernet node** command in the menu bar of the **HW Config** window. In the **Edit Ethernet Node** dialog box press the **Browse...** button to find all the nodes connected to the network. Select the LIKA ROTACOD device type you need to reset the parameters. The MAC address of the encoder is written on the encoder label. Press the **OK** button to confirm.

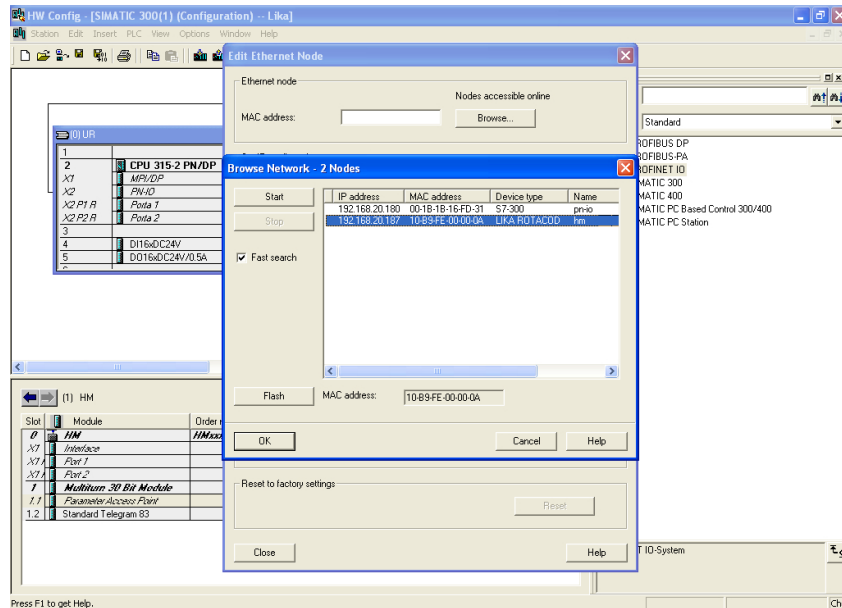

Figure 28 – Restoring default values

The **Edit Ethernet Node** dialog box will show the identification parameters of the chosen device. Now press the **Reset** button in the **Reset to factory settings** box below in the dialog box.

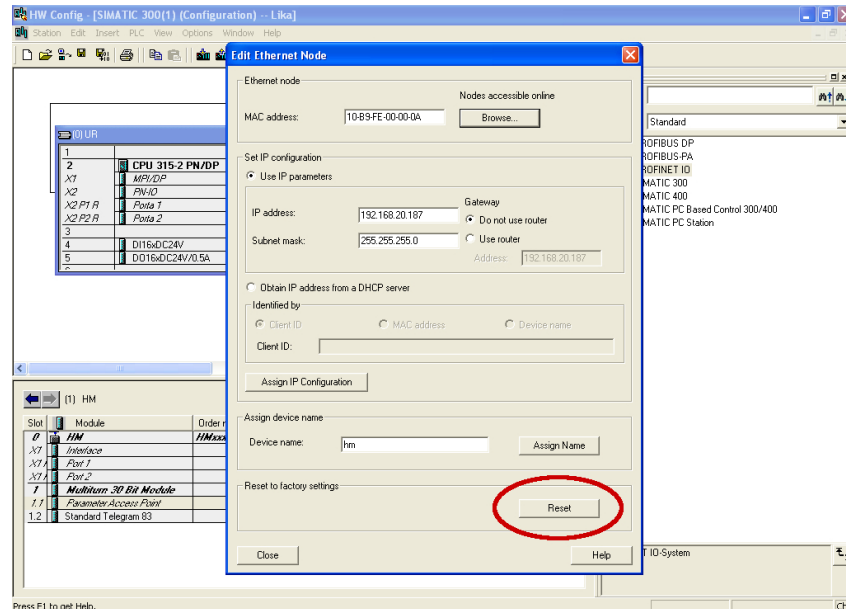

Figure 29 – Reset to factory settings

You will be requested to confirm the operation. Press the **YES** button in the message that appears on the screen.

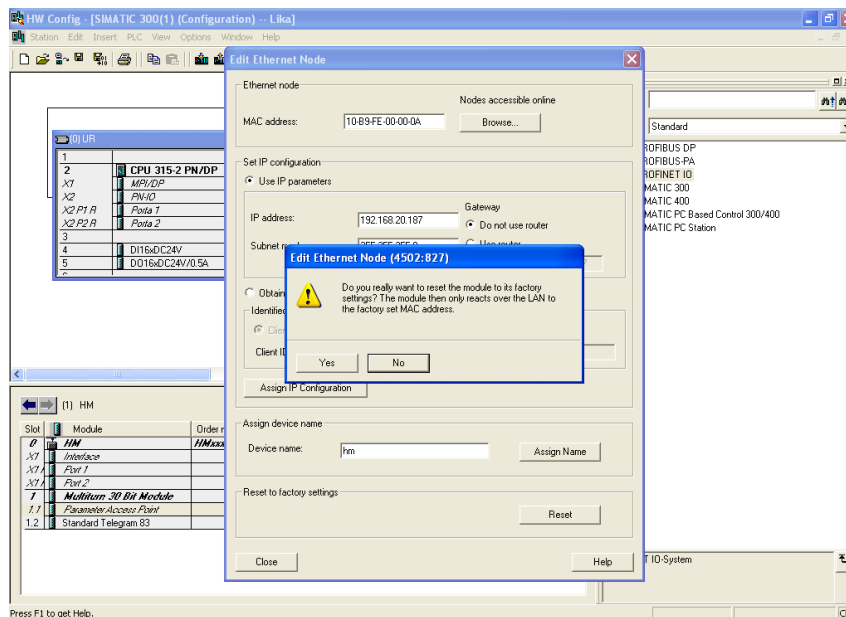

Figure 30 – Reset first confirmation message

If the device is online and an application relation (AR) is currently established, a second message will appear on the screen. Again you will be requested to confirm the operation by pressing the **YES** button.

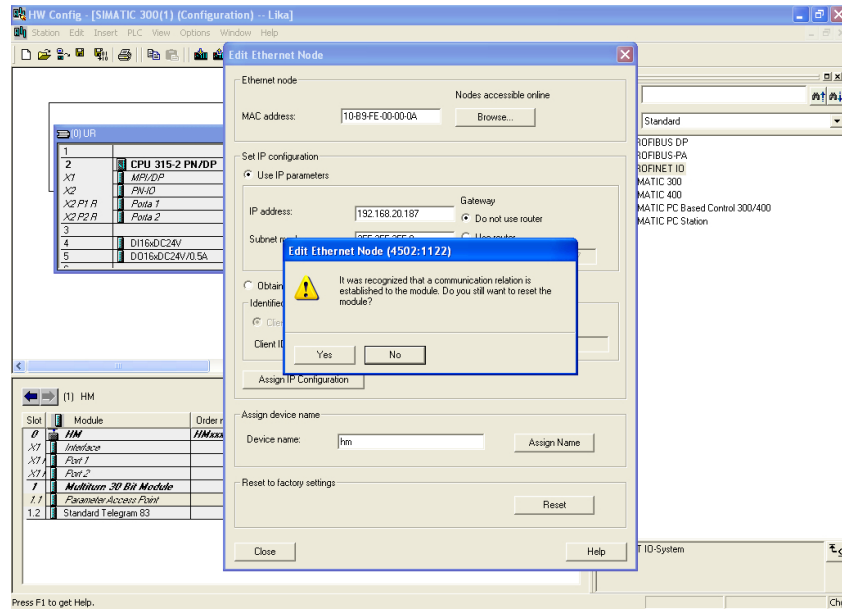

Figure 31 – Reset second confirmation message

Press the **OK** button to close the message.

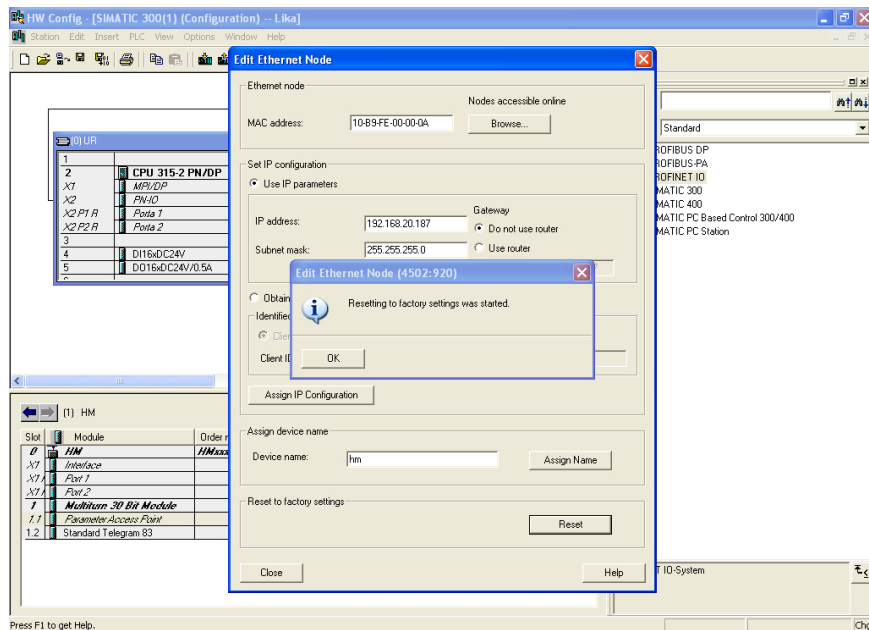

Figure 32 – Reset executed message

When the operation is carried out, browse the network by pressing the **Browse...** button in the **Edit Ethernet Node** dialog box to find all the nodes connected to the network. The LIKA ROTACOD device type will provide the value 0.0.0.0 under the IP address item and a blank string under the Name item.

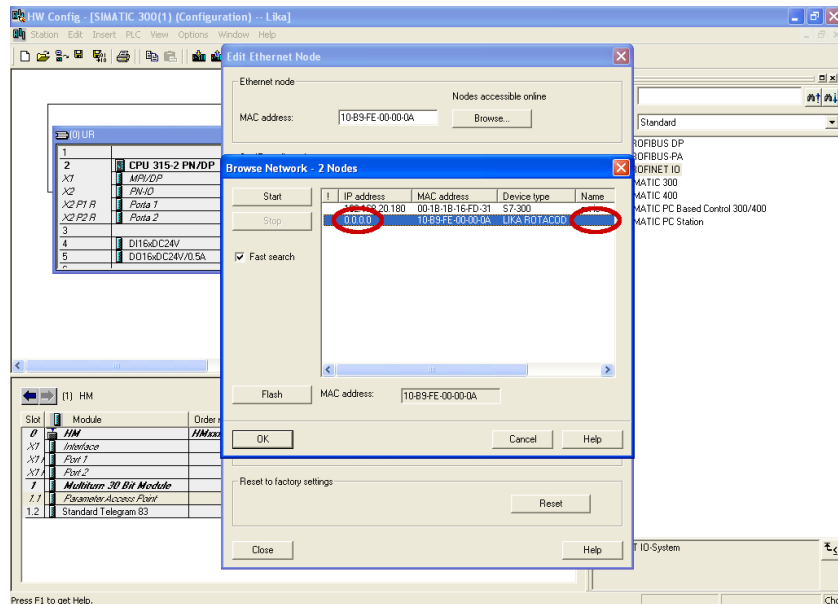

Figure 33 – Checking data after reset

5.7 TO Technology Objects

In order to be able to facilitate the use of technological functions that can be used with a SIMATIC controller, what is known as **Technology Objects** have been introduced in the programming environment of SIMATIC. Within these technology objects, the available functions are encapsulated and provided to the creator of the user program for easy access and the easy use in the programming environment.

Particularly in the "motion control" area are these technology objects used to simplify the control and handling of axes and additional motion control functionalities and to support the user in the creation of a user program with motion control functionalities.

5.7.1 Properties of a technology object (TO)

A technology object (TO) for motion control in the SIMATIC has the following properties:

- The technology object represents a software object in the controller.
- The technology object represents the mechanical components.

- The technology object encapsulates the technological functionality.
- The technology object allows a uniform setting and configuration.
- The technology object ensures a simple connection of the drives and encoders as well as the distributed I/O.
- The technology object encapsulates the mechanical configuration, the monitoring and limitations of the drive and the mechanic that is connected to it.
- The technology object is addressed via PLCopen motion control instructions from the user program.

This guarantees a simple and standardized use of the motion control functionalities in the SIMATIC.

5.7.2 Installing the encoder as a technology object (TO)

If the encoder is used as a TO Technology Object, **Compatibility mode** parameter must be set to 0 = Enable = Compatible with Encoder Profile V3.1.

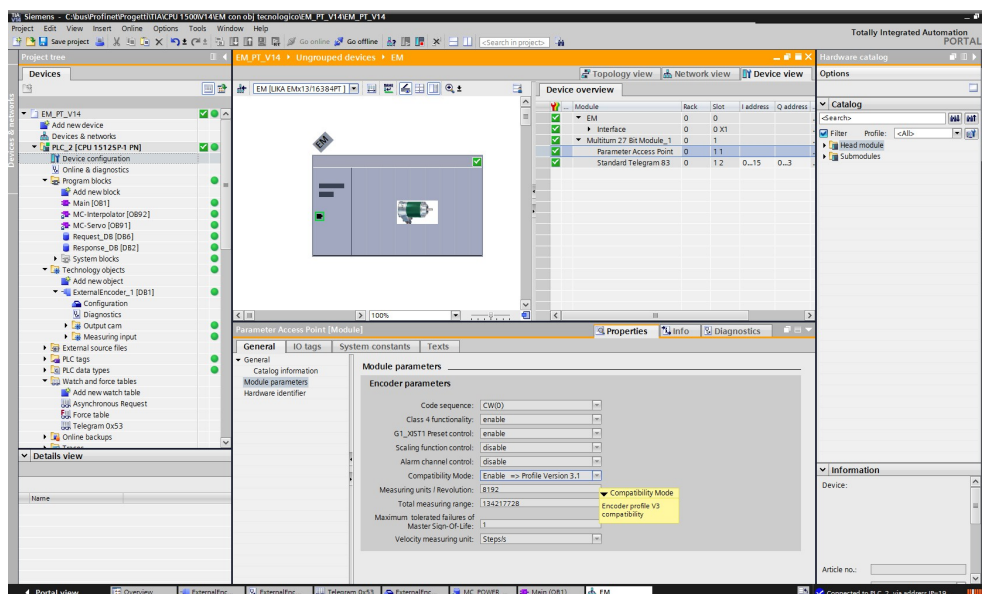

Figure 34 - Checking the **Compatibility mode** parameter setting

The screenshot above was taken using TIA PORTAL V14 with SIEMENS PLC CPU 1512SP-1 PN.

6 Profinet interface

6.1 A brief introduction to Profinet

PROFINET IO is the open industrial network devised for automation applications and built on the Ethernet application layer (TCP/IP and IT standards). For PROFINET IO the layers 1 through 7a of the ISO/OSI (Open Systems Interconnection) reference model are exclusively based on internationally proven standards. The functionality of PROFINET is defined in layer 7b. PROFINET IO complies with IEEE802.3 Ethernet Standard and follows the standards IEC 61158 and IEC61784, so it is 100% Ethernet compatible.

Its technology development and standardization are entrusted to Profibus & Profinet International (PI), the international umbrella organization including members of more than 1400 companies (www.profibus.com).

PROFINET IO is expressly developed to connect controllers (named IO controllers, equivalent to Profibus DP Masters), peripheral devices (named IO devices, similar to Profibus DP Slaves) and programming devices / PCs (named IO supervisors) with Ethernet Real Time (RT) and Isochronous Real Time (IRT) communication all the way. Real Time channel is used for time-critical process data and allows to meet the real-time requirements of the automation engineering (cycle times < 500 μ s, jitter < 1 μ s); while IRT is suitable for sophisticated motion control and high performance applications in factory automation and permits cycle times lower than 250 μ s with less than 1 μ s jitter. The standard TCP/IP channel is used for parametrization, configuration and acyclic read/write operations.

A PROFINET IO system requires at least one IO Controller and one IO Device. The most frequent network topologies can be implemented and even mixed together including Star, Line, Tree and Ring structures by means of copper or fiber-optic cables. The number of devices (each one fitted with its own MAC address, IP address and device name) which can be connected in the PROFINET network is virtually unlimited. The transmission rate is 100Mbit/s with full duplex communication (Fast Ethernet).

PROFINET IO Devices are configured using a configuration tool which acts as the IO Supervisor. The IO Supervisor uses a GSD (General Station Description) file based on XML language, thus it is called GSDML file, see on page 36.

6.2 Profinet encoders from Lika Electronic

PROFINET encoders from Lika Electronic fully comply with the encoder profile specifications V4.1 version 3.162, the encoder profile is based on the PROFIdrive profile. For any information on the encoder profile please refer to the following document:

ENCODER PROFILE. Technical specifications for Profibus and Profinet related to PROFdrive

edited by PI International.

Furthermore these encoders fulfil the requirements of the Application Classes 3 and 4, thus they are intended for clock-synchronous (isochronous) real-time applications with cyclic and synchronous data transmission. Anyway they can also be used in applications without clock synchronization. For detailed information on the application classes refer to the "6.3 Application Class definition" section on page 68.

PROFINET encoders supports the standard telegrams 81, 82, 83 and 84. Further information can be found in the "7.1 Telegrams" section on page 71.

The IO data is transferred to and from the Encoder Object (EO, see the "6.4 Encoder Object model" section on page 69) via the Cyclic Data Exchange Service. The EO comprises the following mandatory functionalities:

- parameters;
- measuring task (i.e. position value, velocity value, ...);
- IO data (cyclical transmission of control and actual values);
- support for Alarm Mechanism.

Among the parameters available in the Profinet encoders from Lika Electronic: code sequence, scaling function, preset (Class 4 functionalities), position readout, offset value, velocity value, velocity measuring unit, acyclic Error Data communication and diagnostic information.

PROFINET at a glance

| Number of stations | Setting the IP-Address | Setting the baud rate | Transmission rate | Cable length | Cable |
|---------------------|------------------------------|-----------------------|------------------------|----------------------|---------------------------------|
| Virtually unlimited | Software / automatic via DCP | - | 100 Mbit/s full duplex | Up to 100 m / 330 ft | M12 D-coded Profinet connectors |

6.2.1 Overview of the encoder profiles

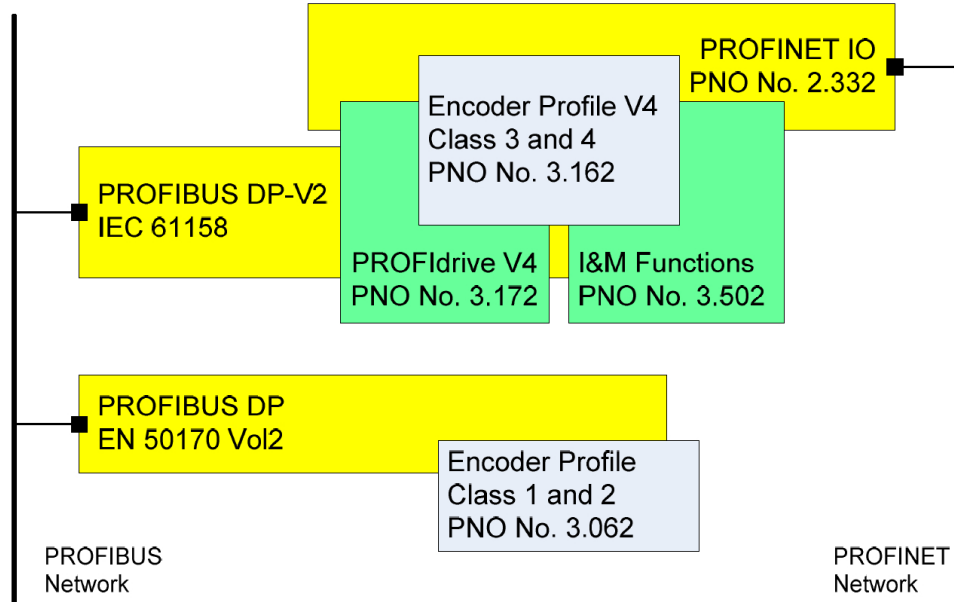

6.3 Application Class definition

The encoder profile defines two application classes: **Class 3** and **Class 4**. A number of mandatory functions are specified for each application class, in addition all optional functions must be recognized by the encoder and handled so that the controller is able to determine whether an optional function is supported.



NOTE

There is no relation between the Encoder application classes and the application classes defined in the PROFIdrive profile.

6.3.1 Application Class 3

Encoder with base mode parameter access and limited parametrization of the encoder functionality. Isochronous mode is not supported.

6.3.2 Application Class 4

Encoder with scaling, preset, isochronous mode and base mode parameter access. A Class 4 configured encoder fully supports all functionalities according to the encoder profile V4.1.

Lika Electronic encoders fulfil the requirements of CLASS 4

6.4 Encoder Object model

The Figure shows the general Encoder Object (EO) architecture. Central element of the EO is the Measuring Task where the measurements are made and the results are calculated. The properties of the EO is represented and controlled by parameters. The parameters are administered in the Parameter Data Base. To access EO parameters, Acyclic Data Exchange service is used. For periodic transportation of control values to the EO and actual values from the EO, the Cyclic Data Exchange service is used. Exception situations out of the Measuring Task and the General State Machine may be signalled by the Alarm Mechanism to the controlling device.

The EO shall comprise as minimum mandatory functionality:

- Parameters;
- Measuring Task;
- IO Data (control value, actual value);
- Support for Alarm Mechanism;
- Optional functionality;
- Clock Synchronous operation.

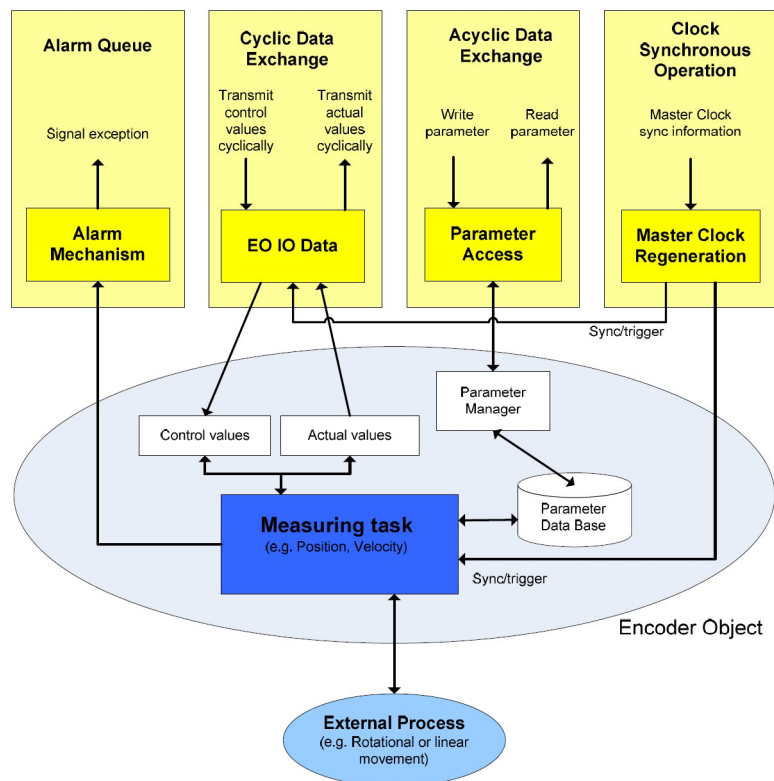

6.5 Encoder object architecture

The Figure shows the general architecture and the mapping of the Encoder Object (EO) architectural elements to Communication Objects of the Peripheral Device for PROFINET IO. General with PROFINET IO the EO is mapped exactly to one Module/Slot. Slot 0 is exclusively reserved for Device representative purpose and therefore shall not be used for any Encoder module. Valid Slot numbers for Encoder Objects are from 1 to 0x7FFF. Every EO contains at least the mandatory Module Access Point (MAP) which is mapped to a dedicated EO representative Submodule. This MAP Submodule contains at least the mandatory Parameter Access Point (PAP) which is mapped to a dedicated Record Data Object. Via the EO representative Submodule (MAP) and the specified Record Data Object the access to the EO parameter manager is possible. The EO parameter manager has access to the EO local Parameter Data Base. In addition to the mandatory MAP submodule, the EO may contain additional submodules which may be used to:

- represent communication end points for IO Data (cyclic data channel) and also to structure the IO Data in data blocks (telegrams, signals).
- represent physical or logical Subobjects of the EO.

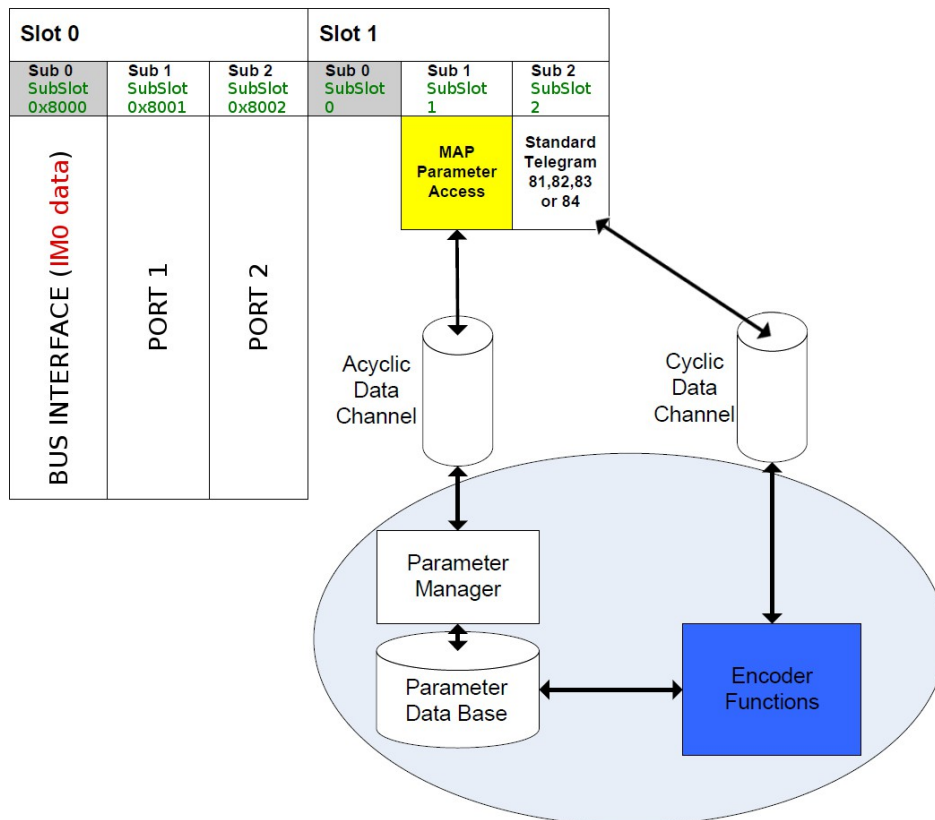

7 PROFINET IO data description

7.1 Telegrams

A telegram is a rigidly defined bit stream carrying data. In each telegram the data length and the type of data which is sent to and from the IO controller is specified. PROFINET interface devices communicate and stay in sync by sending each other telegrams. The encoder profile supports four types of telegrams: Standard Telegram 81, Standard Telegram 82, Standard Telegram 83 and Standard Telegram 84. They are described hereafter. Standard signals are fully described in the "Cyclic Data Exchange – Std signals" section on page 73.

7.1.1 Standard Telegram 81

The Standard Telegram 81 is the default telegram. It uses 4 bytes to output data from the IO controller to the encoder and 12 bytes to input data from the encoder to the IO controller.

Output data CONTROLLER => DEVICE

| | | |
|------------------|----------|---------|
| | 2 bytes | 2 bytes |
| IO Data | 1 | 2 |
| Set point | STW2_ENC | G1_STW |

Input data DEVICE => CONTROLLER

| | | | | | | |
|---------------------|----------|---------|----------|---|----------|---|
| | 2 bytes | 2 bytes | 4 bytes | | 4 bytes | |
| IO Data | 1 | 2 | 3 | 4 | 5 | 6 |
| Actual value | ZSW2_ENC | G1_ZSW | G1_XIST1 | | G1_XIST2 | |

7.1.2 Standard Telegram 82

The Standard Telegram 82 uses 4 bytes to output data from the IO controller to the encoder and 14 bytes to input data from the encoder to the IO controller.

Output data CONTROLLER => DEVICE

| | | |
|------------------|----------|---------|
| | 2 bytes | 2 bytes |
| IO Data | 1 | 2 |
| Set point | STW2_ENC | G1_STW |

Input data DEVICE => CONTROLLER

| | | | | | | | |
|---------------------|----------|---------|----------|---|----------|---|---------|
| | 2 bytes | 2 bytes | 4 bytes | | 4 bytes | | 2 bytes |
| IO Data | 1 | 2 | 3 | 4 | 5 | 6 | 7 |
| Actual value | ZSW2_ENC | G1_ZSW | G1_XIST1 | | G1_XIST2 | | NIST_A |

7.1.3 Standard Telegram 83

The Standard Telegram 83 uses 4 bytes to output data from the IO controller to the encoder and 16 bytes to input data from the encoder to the IO controller.

Output data CONTROLLER => DEVICE

| | | |
|------------------|-----------------|---------------|
| | 2 bytes | 2 bytes |
| IO Data | 1 | 2 |
| Set point | STW2_ENC | G1_STW |

Input data DEVICE => CONTROLLER

| | | | | | | | | |
|---------------------|-----------------|---------------|-----------------|-----------------|---------------|---|---|---|
| | 2 bytes | 2 bytes | 4 bytes | 4 bytes | 4 bytes | | | |
| IO Data | 1 | 2 | 3 | 4 | 5 | 6 | 7 | 8 |
| Actual value | ZSW2_ENC | G1_ZSW | G1_XIST1 | G1_XIST2 | NIST_B | | | |

7.1.4 Standard Telegram 84

The Standard Telegram 84 uses 4 bytes to output data from the IO controller to the encoder and 20 bytes to input data from the encoder to the IO controller.

Output data CONTROLLER => DEVICE

| | | |
|------------------|-----------------|---------------|
| | 2 bytes | 2 bytes |
| IO Data | 1 | 2 |
| Set point | STW2_ENC | G1_STW |

Input data DEVICE => CONTROLLER

| | | | | | | | | | | |
|---------------------|-----------------|---------------|-----------------|-----------------|---------------|---|---|---|---|----|
| | 2 bytes | 2 bytes | 8 bytes | 4 bytes | 4 bytes | | | | | |
| IO Data | 1 | 2 | 3 | 4 | 5 | 6 | 7 | 8 | 9 | 10 |
| Actual value | ZSW2_ENC | G1_ZSW | G1_XIST3 | G1_XIST2 | NIST_B | | | | | |



NOTE

In the Standard Telegram 84, **G1_XIST2** is used to transfer the error codes and optionally the position values if the measuring length exceeds 64 bits.

8 Cyclic Data Exchange – Std signals

IO data is transferred via the Cyclic Data Exchange. A series of standard signals are defined to configure the IO data. In the following table the standard signals are summarily described.

| Significance | Abbreviation | Length (bits) | Data type | Page |
|-----------------------------------|-----------------|---------------|-----------|------|
| Sensor 1 position current value 1 | G1_XIST1 | 32 | Unsigned | 75 |
| Sensor 1 position current value 2 | G1_XIST2 | 32 | Unsigned | 76 |
| Sensor 1 position current value 3 | G1_XIST3 | 64 | Unsigned | 76 |
| Encoder Control word 2 | STW2_ENC | 16 | Unsigned | 77 |
| Encoder Status word 2 | ZSW2_ENC | 16 | Unsigned | 78 |
| Sensor 1 Control word | G1_STW | 16 | Unsigned | 78 |
| Sensor 1 Status word | G1_ZSW | 16 | Unsigned | 82 |
| Speed current value A | NIST_A | 16 | Signed | 82 |
| Speed current value B | NIST_B | 32 | Signed | 82 |

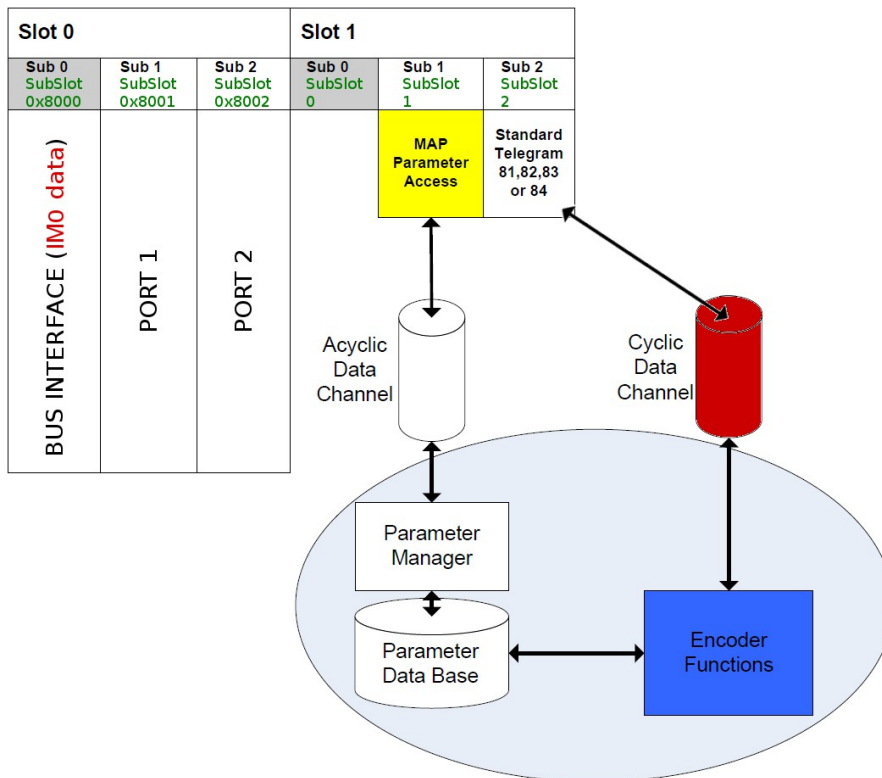
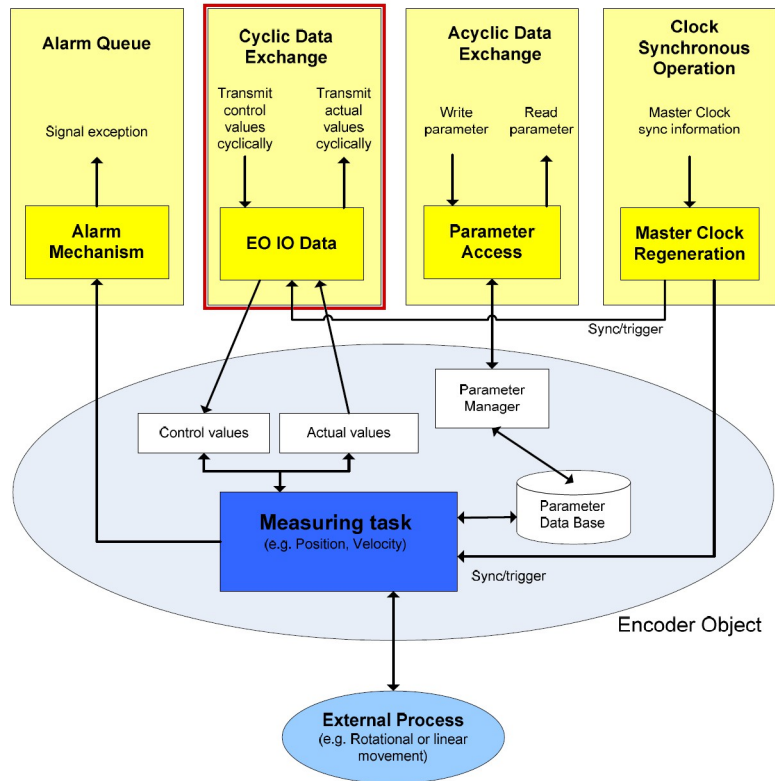

8.1 List of the available standard signals

G1_XIST1

[Unsigned, 32 bits]

It is defined as Sensor 1 current position value 1. This signal is the current (real) absolute position of the encoder expressed in binary notation.

Format definition:

- all values are represented in binary notation;
- the recommended default shift factor is zero (right aligned value) for both **G1_XIST1** and **G1_XIST2**;
- the settings in the encoder parameter data affect the position value in both **G1_XIST1** and **G1_XIST2**.



EXAMPLE

Here follows a format example.

25-bit absolute multiturn encoder, 13-bit singleturn resolution (8192 counts per revolution), 12-bit multiturn resolution (4096 revolutions)

M = Multiturn value, number of revolutions

S = Singleturn value, number of counts per revolution

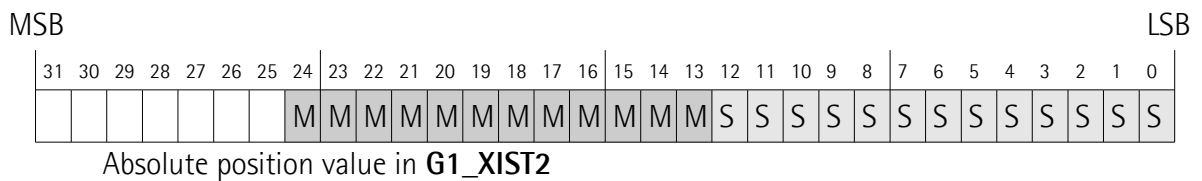
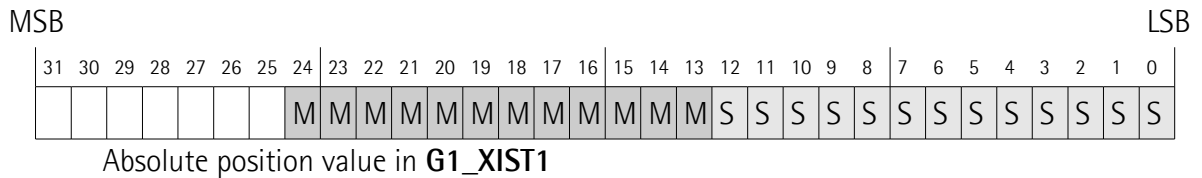

G1_XIST2

[Unsigned, 32 bits]

It is defined as Sensor 1 current position value 2. By default this signal is the current (real) absolute position of the encoder expressed in binary notation yet it has a different meaning if an error is active.

If no error is active:

this signal informs about the current position value of the encoder, provided that the bit **Request absolute value cyclically** (bit 13 of control word **G1_STW**) is set to 1; otherwise this value is 0.

If an error is active:

this signal informs about the active error. For the complete list of the error codes refer to the "10.3 Error codes in G1_XIST2" section on page 101.

Format definition:

- all values are represented in binary notation;
- the recommended default shift factor is zero (right aligned value) for both **G1_XIST1** and **G1_XIST2**;
- the settings in the encoder parameter data affect the position value in both **G1_XIST1** and **G1_XIST2**;
- **G1_XIST2** displays the error telegram instead of the position value if an error occurs.

For the format example see **G1_XIST1** above.

G1_XIST3

[Unsigned, 64 bits]

It is defined as Sensor 1 current position value 3. This 64-bit position value is intended to support the encoders having a measuring length which exceeds 32 bits. **G1_XIST3** has the following format:

- binary format;
- the current position value is always right aligned, a shifting factor is not used;
- the settings in the encoder parameter data affect the position value in **G1_XIST3** if Application Class 4 is enabled.

| | | | | |
|----------------|-----------------------|---|---|---|
| IO data | 1 | 2 | 3 | 4 |
| Format | 64-bit position value | | | |

STW2_ENC

[Unsigned, 16 bits]

It is defined as Encoder control word 2. Control word **STW2_ENC** includes the **Control by PLC** mechanisms from PROFIdrive STW1 and the **Controller Sign-Of-Life** mechanism from PROFIdrive STW2.

| Bit | Meaning |
|-----------|--------------------------------|
| 0 ... 6 | Reserved |
| 7 | Not used |
| 8 & 9 | Reserved |
| 10 | Control by PLC |
| 11 | Reserved |
| 12 ... 15 | Controller Sign-Of-Life |

Control by PLC

Bit 10

If the **Compatibility mode** is enabled (see on page 93), then bit 10 **Control by PLC** is ignored. In this case control word **G1_STW** and setpoint are always checked.

If the **Compatibility mode** is disabled (see on page 93), then bit 10 **Control by PLC** is checked. So control word **G1_STW** and setpoint are checked only if the bit **Control by PLC** is set.

| Bit | Value | Significance | Comment |
|-----|-------|---------------------|---|
| 10 | 1 | Control from PLC | Control via interface, EO IO Data is processed. |
| | 0 | No control from PLC | EO IO Data not valid, except Sign-Of-Life. |

Controller Sign-Of-Life

Bits 12 ... 15

For more information on the control word **STW2_ENC** please refer to the PROFIdrive Technical Specification document.

ZSW2_ENC

[Unsigned, 16 bits]

It is defined as Encoder status word 2. The encoder status word 2 **ZSW2_ENC** includes the Control by PLC mechanism from PROFIdrive ZSW1 and the Slave Sign-Of-Life mechanism from PROFIdrive ZSW2.

| Bit | Meaning |
|-----------|-----------------------------|
| 0 ... 2 | Reserved |
| 3 | Not used |
| 4 ... 8 | Reserved |
| 9 | Control requested |
| 10 & 11 | Reserved |
| 12 ... 15 | Encoder Sign-Of-Life |

Control requested

Bit 9

| Bit | Value | Significance | Comment |
|-----|-------|----------------------|--|
| 9 | 1 | Control Requested | The automation system is requested to assume control. |
| | 0 | No Control requested | Control by the automation system is not possible, only possible at the device or by another interface. |

Encoder Sign-Of-Life

Bits 12 ... 15

For more information on the status word 2 **ZSW2_ENC** please refer to the PROFIdrive Technical Specification document.

G1_STW

[Unsigned, 16 bits]

It is defined as Sensor 1 control word. This control word controls the functionality of major encoder functions.

| Bit | Meaning |
|----------|---|
| 0 ... 7 | Not used |
| 8 ... 10 | Reserved |
| 11 | Home position mode |
| 12 | Request set/shift of home position |

| | |
|----|--|
| 13 | Request absolute value cyclically |
| 14 | Activate parking sensor |
| 15 | Acknowledging a sensor error |



NOTE

If the **Activate parking sensor** is activated (bit 14 = 1) the encoder is still on bus with the slave Sign-Of-Life active and the encoder error and diagnostics switched off.

Home position mode

Bit 11

Request set/shift of home position

Bit 12

The preset function is controlled by bits 11 and 12 in this Sensor 1 control word **G1_STW** and acknowledged by the bit 12 **Set/shift of home position executed** in the sensor status word **G1_ZSW**. The preset value is 0 by default and may be set by an acyclic data exchange parameter defined in the parameters section (see **P65000 – Preset value** on page 87). The preset function has an absolute and a relative operating mode selectable by mean of the bit 11 **Home position mode** in this Sensor 1 control word **G1_STW** (0 = absolute; 1 = relative). Bit 11 and bit 12 in the Sensor 1 control word **G1_STW** control the preset function as described in the table below.

| Bit 12 | Bit 11 | Action |
|--------|--------|---|
| 0 | X | Normal operating mode. The encoder will make no change in the output value. |
| 1 | 0 | Preset mode absolute The encoder reads the current position value and calculates an internal offset value from the preset value P65000 – Preset value and the read position value. The position value is then shifted with the calculated offset value to get the current position value equal to the preset value. The encoder acknowledges the preset by setting the bit 12 Set/shift of home position executed in the sensor status word G1_ZSW . Now bit 12 Request set/shift of home position in the sensor 1 control word G1_STW can be set to zero by the Master. The encoder will end the preset cycle by clearing the bit 12 Set/shift of home position executed in the sensor status word G1_ZSW . The new internal offset value can be read with an acyclic data exchange parameter (if implemented) and is securely stored |

| | | |
|---|---|---|
| | | in case of voltage breakdown and uploaded again at each power on. |
| 1 | 1 | <p>Preset mode relative (offset) The encoder uses the preset value P65000 – Preset value as a relative offset value. In this mode the current position value is shifted by the value deriving from the preset value.</p> <p> EXAMPLE A preset value "1000" is intended to shift the current position value by 1000 steps in the positive counting direction. So a "real" position value of "5000" will have the value "6000" after the relative shifting sequence. The encoder will set bit 12 Set/shift of home position executed in the sensor status word G1_ZSW to acknowledge the execution of the shifting. Bit 12 Request set/shift of home position in the sensor control word G1_STW can now be set to zero by the Master. The encoder will end the preset cycle by clearing the bit 12 Set/shift of home position executed in the sensor status word G1_ZSW. The internal offset value will be shifted according to the transferred preset value. The new offset value is securely stored in case of voltage breakdown and uploaded again at each power on.</p> |

The Preset command automatically saves the calculated internal offset values.



NOTE

Refer also to the index **P65000 – Preset value** on page 87; to **G1_XIST1 preset control** on page 91; and to the "14.2 Preset diagram" section on page 140. See also the "15.2 Setting the preset value" section on page 156.



EXAMPLE

An example of setting the Preset value is provided on page 131.

Request absolute value cyclically

Bit 13

| Bit | Significance | Comment |
|-----|--|---|
| 13 | =1 : Request absolute value cyclically | Request of additional cyclic transmission of the current absolute position in G1_XIST2 . |

Activate parking sensor

Bit 14

| Bit | Significance | Comment |
|-----|------------------------------|--|
| 14 | =1 : Activate parking sensor | Request to stop monitoring the measuring system and the current value measurements in the drive. This makes it possible to disconnect the encoder from the line without having to change the drive configuration or causing a fault. In this case all current errors of the encoder are cleared. The parking of the encoder while the drive is running is not allowed and will result in a sensor interface error (error code 0x03 in G1_XIST2). |

See also "14.3 Parking sensor diagram" on page 141.

Acknowledging a sensor error

Bit 15

| Bit | Significance | Comment |
|-----|-----------------------------------|---|
| 15 | =1 : Acknowledging a sensor error | Request to acknowledge a sensor error (bit 15 Sensor error of G1_ZSW). |

G1_ZSW

[Unsigned, 16 bits]

It is defined as Sensor 1 status word. This status word defines the states, acknowledgements and error messages of the encoder and its main functions.

| Bit | Meaning |
|---------|---|
| 0 ... 9 | Not used |
| 10 | Reserved |
| 11 | Requirements of error acknowledge detected |
| 12 | Set/shift of home position executed |
| 13 | Transmit absolute value cyclically |
| 14 | Parking sensor active |
| 15 | Sensor error |



NOTE

If bit13 **Transmit absolute value cyclically** or bit15 **Sensor error** are not set, there is no valid value or error code transferred in **G1_XIST2**.



NOTE

Bit 13 **Transmit absolute value cyclically** and bit 15 **Sensor error** cannot be set at the same time as they are used to indicate either a valid position value transmission (bit 13) or the error code transmission (bit 15) in **G1_XIST2**.

NIST_A

[Signed, 16 bits]

It is defined as current velocity value A.

Velocity value is calculated every 100 ms.

Refer also to the parameter **Velocity measuring units** on page 96.

NIST_B

[Signed, 32 bits]

It is defined as current velocity value B.

Velocity value is calculated every 100 ms.

Refer also to the parameter **Velocity measuring units** on page 96.

9 Acyclic Data Exchange

In addition to the Cyclic Data Exchange (see the "Cyclic Data Exchange – Std signals" section on page 73), the Acyclic Data Exchange gives the possibility to read and write parameters over the non real time channel.

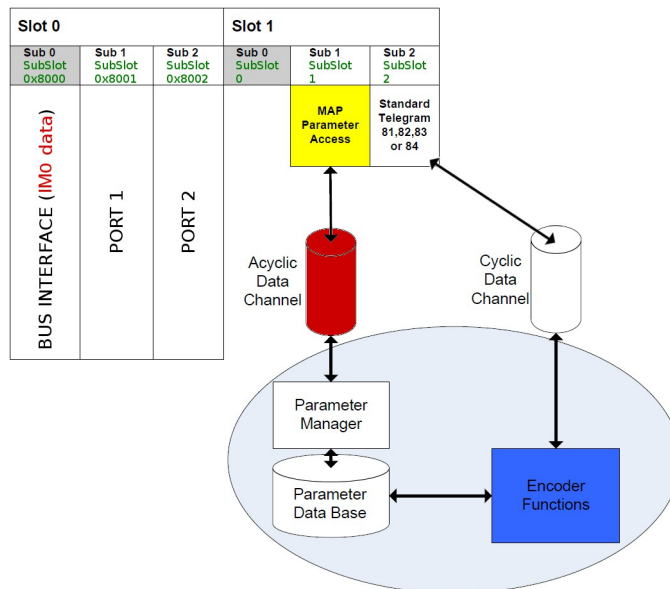
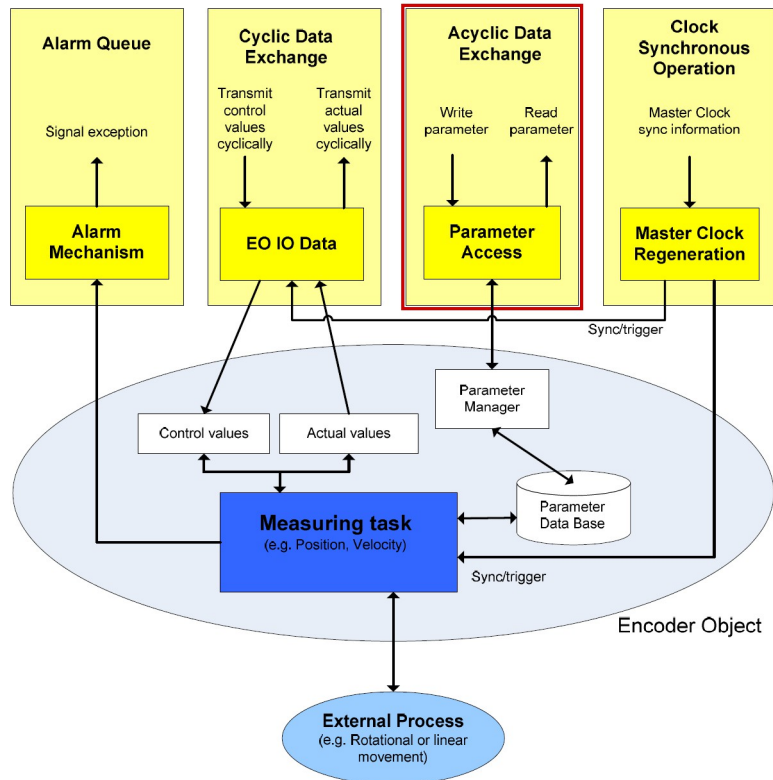

9.1 Index 0xAFF0: Identification & Maintenance (I&M) functions

Profinet encoders from Lika Electronic only implement I&M 0 Module (IM0).

IM0 is accessible with record 0xAFF0 and provides general information on the device such as vendor ID, order ID, serial number, etc.

| Description | Number of bytes |
|-----------------------------|-----------------|
| BLOCKHEADER | 6 |
| MANUFACTURER ID (VENDOR ID) | 6 |
| ORDER ID | 20 |
| SERIAL NUMBER | 16 |
| HARDWARE REVISION | 2 |
| SOFTWARE REVISION | 4 |
| REVISION COUNTER | 2 |
| PROFILE ID (API) | 2 |
| PROFILE SPECIFIC TYPE | 2 |
| IM VERSION | 2 |
| IM SUPPORTED | 2 |

9.2 Index 0xB02E : supported PROFIdrive specific parameters

P922 – Telegram Selection

[Unsigned16, RO]

It indicates the type of telegram which is currently in use. Possible values: 81, 82, 83 and 84.

P964 – Profidrive Parameter : Device identification

[Array[0 ... 5], unsigned16, RO]

| Index | Sub | Meaning | Value | Access |
|-------|-----|--|-------|--------|
| 964 | 0 | Manufacturer ID (Vendor ID assigned by PI) | 0x239 | RO |
| 964 | 1 | DU Drive unit type (Vendor specific) | 1 | RO |
| 964 | 2 | Software version | xxxx | RO |
| 964 | 3 | Software year | yyyy | RO |
| 964 | 4 | Software day and month | dd.mm | RO |
| 964 | 5 | Number of Drive Object (DO) | 1 | RO |

P965 – Encoder profile number

[Octet string 2, RO]

| Index | Sub | Meaning | Value | Access |
|-------|-----|--|----------|--------|
| 965 | 0 | Encoder profile number | 0x3D | RO |
| 965 | 1 | Encoder profile version, set by customer | 31 or 41 | RO |

P971 – Transfer to non volatile memory

[Unsigned16, RW]

It is used to save the current local parameters on a non volatile memory. Write "1" to save the parameters. The encoder confirms save by writing "0" on this parameter.

| Index | Sub | Meaning | Value | Access |
|-------|-----|-----------------------------|----------|--------|
| 971 | 0 | Save on non volatile memory | variable | RW |

P975 – Encoder object identification

[Array[0 ... 7], unsigned16, RO]

| Index | Sub | Meaning | Value | Access |
|-------|-----|--|--|--------|
| 975 | 0 | Manufacturer ID (Vendor ID assigned by PI) | 0x239 | RO |
| 975 | 1 | DO type (Vendor specific) | 0x01 | RO |
| 975 | 2 | Software version | xx.xx | RO |
| 975 | 3 | Software year | yyyy | RO |
| 975 | 4 | Software day and month | dd.mm | RO |
| 975 | 5 | Profidrive DO type classification | 0x05 encoder interface | RO |
| 975 | 6 | Profidrive DO subclassification 1 | 0x8000 (encoder Application Class 4 supported) | RO |
| 975 | 7 | Drive object ID (DO ID) | 0x01 | RO |

P979 – Sensor format

[Array[0 ... 5], unsigned16, RO]

| Index | Sub | Meaning | Value | Access |
|-------|-----|----------------------------------|------------|--------|
| 979 | 0 | Header | 0x00005011 | RO |
| 979 | 1 | Sensor type | 0x80000000 | RO |
| 979 | 2 | Sensor Resolution | variable | RO |
| 979 | 3 | Shift factor for G1_XIST1 | 0 | RO |
| 979 | 4 | Shift factor for G1_XIST2 | 0 | RO |
| 979 | 5 | Determinable resolutions | variable | RO |

P980 – Number list of defined parameter

[Array[0 ... 8], unsigned16, RO]

| Index | Sub | Meaning | Value | Access |
|-------|-----|--|-------|--------|
| 980 | 0 | P922 – Telegram Selection | 922 | RO |
| 980 | 1 | P964 – Profidrive Parameter : Device identification | 964 | RO |
| 980 | 2 | P965 – Encoder profile number | 965 | RO |
| 980 | 3 | P971 – Transfer to non volatile memory | 971 | RO |
| 980 | 4 | P975 – Encoder object identification | 975 | RO |
| 980 | 5 | P979 – Sensor format | 979 | RO |
| 980 | 6 | P61001 – IP of station | 61001 | RO |
| 980 | 7 | P65000 – Preset value | 65000 | RO |
| 980 | 8 | P65001 – Operating status | 65001 | RO |

P61001 – IP of station

[Unsigned32, RO]

| Index | Sub | Meaning | Value | Access |
|-------|-----|------------------------------------|----------|--------|
| 61001 | 0 | IP address assigned to the encoder | variable | RO |

9.3 Index 0xB02E : supported encoder specific parameters

P65000 – Preset value

[Unsigned32, RW]

Preset mode absolute

Preset function is meant to assign a desired value to a known physical position of the system. The chosen physical position will get the value set next to this index and all the previous and following mechanical positions will get a value according to it.

Preset mode relative (offset)

The encoder uses the preset value **P65000 – Preset value** as a relative offset value. In this mode the current position value is shifted by the value deriving from this preset value.

Preset value can be saved on the internal memory using the parameter **P971 – Transfer to non volatile memory**.

See also **Home position mode** and **Request set/shift of home position** in **G1_STW** on page 79; and **G1_XIST1 preset control** on page 91.

| Index | Sub | Meaning | Value | Access |
|-------|-----|--------------|----------|--------|
| 65000 | 0 | Preset value | variable | RW |



EXAMPLE

An example of setting the Preset value is provided on page 131.

P65001 – Operating status

[Array[0 ... 11], unsigned32, RO]

This parameter has a read only structure where information on the encoder operating status can be found. It is a complement to the PROFIdrive parameter **979** described in the PROFIdrive profile.

| Index | Sub | Meaning | Value | Access |
|-------|-----|------------------|-------------------------------------|--------|
| 65001 | 0 | Header | 0x000C0101 | RO |
| 65001 | 1 | Operating status | See "Operating status table values" | RO |
| 65001 | 2 | Faults | See "Faults table" | RO |

| | | | | |
|-------|----|--|----------------|----|
| 65001 | 3 | Supported faults | 0x0030 | RO |
| 65001 | 4 | Warnings (*) | 0x0 | RO |
| 65001 | 5 | Supported warnings | 0x0 | RO |
| 65001 | 6 | Encoder profile version (**) | 0x401 | RO |
| 65001 | 7 | Operating time | 0xFFFFFFFF | RO |
| 65001 | 8 | Offset value (related to G1_XIST1) | variable | RO |
| 65001 | 9 | Measuring units per revolution | variable | RO |
| 65001 | 10 | Total measuring range in measuring units | variable | RO |
| 65001 | 11 | Velocity measuring unit (user setting) | variable (***) | RO |

(*) Warnings are not supported in this encoder.

(**) The encoder profile version is the version of the encoder profile document implemented in the encoder. This parameter is not affected by the **Compatibility mode** settings.

(***) See **Velocity measuring units** in the "9.4 Index 0xBF00 : user parameter data" section on page 96.

Operating status table values

| Bit | Meaning |
|----------|--------------------------------------|
| 0 | Code sequence |
| 1 | Class 4 functionality |
| 2 | G1_XIST1 preset control |
| 3 | Scaling function control |
| 4 | Alarm channel control |
| 5 | Compatibility mode |
| 6 & 7 | Reserved to the encoder manufacturer |
| 8 ... 31 | Reserved for future use |

Faults table

| Bit | Meaning |
|----------|--------------------------|
| 0 ... 3 | Not used |
| 4 | Commissioning diagnostic |
| 5 | Memory error |
| 6 ... 31 | Not used |

Supported faults table

| Bit | Meaning |
|----------|--|
| 0 ... 3 | Not used |
| 4 | Commissioning diagnostics supported |
| 5 | Memory error supported |
| 6 ... 31 | Not used |

Offset value is calculated in the preset function and is intended to shift the position value. The offset value is saved on the internal memory. This parameter is a read-only parameter.

9.4 Index 0xBF00 : user parameter data

The 31-byte user parameter data listed in the table below is sent to the encoder in the start-up phase using the data record 0xBF00.

| Parameter | Data Type | Default | Comment | User Data Octet Number |
|--------------------------------------|------------|--------------------------------|---|------------------------|
| Code sequence | Bit | 0 (CW) | | Byte 0 bit 0 |
| Class 4 functionality | Bit | 1 (enabled) | | Byte 0 bit 1 |
| G1_XIST1 preset control | Bit | 0 (enabled) | | Byte 0 bit 2 |
| Scaling function control | Bit | 0 (disabled) | | Byte 0 bit 3 |
| Alarm channel control | Bit | 0 (disabled) | Only supported in Compatibility mode | Byte 0 bit 4 |
| Compatibility mode | Bit | 1 (disabled) (profile V4.1) | | Byte 0 bit 5 |
| Reserved | | 0 | Set to 0 | Byte 0 bits 6-7 |
| Measuring units / Revolution | Unsigned64 | variable | | Bytes 1-8 |
| Total measuring range | Unsigned64 | variable | | Bytes 9-16 |
| Maximum Master Sign-Of-Life failures | Unsigned8 | 1 | Only supported in Compatibility mode | Byte 17 |
| Velocity measuring units | Unsigned8 | 0 (Steps/rev) | | Byte 18 |
| Reserved | | 0x00 | Set to 0 | Bytes 19-30 |



NOTE

Default values are highlighted in **bold** in the following tables.

Code sequence

Code sequence sets whether the absolute position value output by the encoder increases when the encoder shaft rotates clockwise (0 = CW) or counter-clockwise (1 = CCW). CW and CCW rotations are viewed from shaft end. This parameter is processed only if **Class 4 functionality** is enabled.

| Attribute | Meaning | Value |
|-----------|--|----------|
| CW | Absolute position value increasing with clockwise rotation (viewed from shaft end) | 0 |
| CCW | Absolute position value increasing with counter-clockwise rotation (viewed from shaft end) | 1 |



WARNING

Changing this value causes also the position calculated by the controller to be necessarily affected. Therefore it is mandatory to execute a new preset after setting this parameter.

Class 4 functionality

For any information on the implemented Application Classes refer to the "6.3 Application Class definition" section on page 68.

If it is enabled, **Code sequence**, **G1_XIST1 preset control** and **Scaling function control** affect the position value in **G1_XIST1**, **G1_XIST2** and **G1_XIST3**. However the preset will not affect the position value in **G1_XIST1** if the parameter **G1_XIST1 preset control** is disabled; it will always affect **G1_XIST2** and **G1_XIST3** instead.

| Attribute | Meaning | Value |
|-----------|--|-------|
| Disable | Code sequence , G1_XIST1 preset control and Scaling function control disabled | 0 |
| Enable | Code sequence , G1_XIST1 preset control and Scaling function control enabled | 1 |

G1_XIST1 preset control

This parameter is available only if **Class 4 functionality** is enabled.

This parameter controls the effect of a preset on the **G1_XIST1** actual value. When it is enabled, Preset will affect the position value in **G1_XIST1**.

| Attribute | Meaning | Value |
|-----------|---|-------|
| Enable | G1_XIST1 is affected by a Preset command | 0 |
| Disable | Preset does not affect G1_XIST1 | 1 |



WARNING

G1_XIST1 preset control is disabled by setting the value 1.



NOTE

There is no functionality of this parameter if the **Class 4 functionality** parameter is disabled.



EXAMPLE

An example of setting the Preset value is provided on page 131.

Scaling function control

This parameter enables / disables the Scaling function. When this parameter is disabled, the device uses the **hardware** singleturn and multiturn resolutions; when it is enabled, the device uses the resolutions set next to the parameters **Measuring units / Revolution** and **Total measuring range**. Refer also to the "Scaling function parameters" section on page 93.

| Attribute | Meaning | Value |
|-----------|---------------------------|-------|
| Disable | Scaling function disabled | 0 |
| Enable | Scaling function enabled | 1 |



NOTE

There is no functionality of this parameter if the **Class 4 functionality** parameter is disabled.

Alarm channel control

This parameter enables / disables the encoder specific Alarm channel transferred as Channel Related Diagnosis. This functionality is used to limit the amount of data sent in isochronous mode.

If the value is zero (0 = default value), only the communication related alarms are sent via the alarm channel. If the value is one (1), also the encoder specific faults and warnings are sent via the alarm channel.

For further information refer also to the "10.2 Error messages via the Alarm Channel" section on page 100.

| Attribute | Meaning | Value |
|-----------|-------------------------------|-------|
| Disable | No profile specific diagnosis | 0 |
| Enable | Profile specific diagnosis | 1 |



NOTE

This parameter is only supported in compatibility mode (see **Compatibility mode** on page 93).

Compatibility mode

This parameter defines whether the encoder has to run in a mode compatible with Version 3.1 of the Encoder Profile. See the table below for an overview of the functions affected when the compatibility mode is enabled.

| Attribute | Meaning | Value |
|-----------|---|-------|
| Enable | Compatibility with Encoder Profile V3.1 | 0 |
| Disable | No backward compatibility | 1 |

| Function | Compatibility mode Enabled (=0) | Compatibility mode Disabled (=1) |
|--|--|--|
| Control by PLC (STW2_ENC) | Ignored. The control word G1_STW and setpoint values are always valid. Control requested (ZSW2_ENC) is not supported and is set to 0 | Supported |
| User parameter Maximum Master Sign-Of-Life failures | Supported | Not supported. One Sign-Of-Life failure tolerated. P925 is optional to control the life sign monitoring |
| User parameter Alarm channel control | Supported | Not supported. The application alarm channel is active and controlled by a PROFIdrive parameter |
| P965 – Encoder profile number | 31 (V3.1) | 41 (V4.1) |



WARNING

If the encoder is used as a TO Technology Object (see "5.7 TO Technology Objects" section on page 64), **Compatibility mode** parameter must be set to 0 = Enable = Compatible with Encoder Profile V3.1.

Scaling function parameters

Using the scaling function parameters the encoder absolute position value is converted by software in order to change the resolution of the encoder. The scaling parameters will only be activated if the parameters **Class 4 functionality** and **Scaling function control** are enabled.

The permissible range for the scaling parameters is limited by the hardware encoder resolution.



EXAMPLE

In a 25-bit encoder having a singleturn resolution of 13 bits (8192 cpr) and a multiturn resolution of 12 bits (4096 revolutions), the permissible value for the **Measuring units / Revolution** is between 2^0 and 2^{13} ($2^{13} = 8192$) while the permissible value for the **Total measuring range** is between 2 and 2^{25} ($2^{25} = 33554432$).

Measuring units / Revolution

It is used to program a user specific resolution per each revolution (singleturn resolution). Allowed values are equal to or lower than the hardware counts per revolution (physical singleturn resolution). We suggest setting values that are a power of 2 (1, 2, 4, ... 2048, 4096, ...). See the parameter **Total measuring range** below.

Default = hardware counts per revolution (min. = 1, max. = hardware counts per revolution)



NOTE

There is no functionality of this parameter if the **Scaling function control** parameter is disabled.



EXAMPLE

The HS58 PT Profinet singleturn encoder has a singleturn resolution of 18 bits (262144 cpr); the permissible value for the **Measuring units / Revolution** will be between 2^0 and 2^{18} ($2^{18} = 262144$).



NOTE

When you change the value next to this parameter, then you are required to enter a new preset.

Total measuring range

This parameter sets the number of distinguishable steps over the total measuring range. Allowed values are equal to or lower than the total hardware resolution value (physical multiturn resolution).

We recommend the **Number of revolutions** to be set to a power of 2.

The set **Number of revolutions** results from the following calculation:

$$\text{Number of revolutions} = \frac{\text{Total measuring range}}{\text{Measuring units / Revolution}}$$

Setting the **Number of revolutions** to a value which is a power of 2 is meant to avoid problems when using the device in endless operations requiring the physical zero to be overstepped. If you set the **Number of revolutions** which is not a power of 2, a so-called "Red Zone" is generated before the physical zero. For more detailed information refer to the 9.5 "Red Zone" section on page 97).
 Default = total hardware resolution (min. = 2, max. = total hardware resolution)



NOTE

There is no functionality of this parameter if the **Scaling function control** parameter is disabled.



EXAMPLE

The HM58 PT Profinet encoder has a singleturn resolution of 16 bits (65536 cpr) and a multiturn resolution of 14 bits (16384 revolutions); the permissible value for the **Measuring units / Revolution** will be between 2^0 and 2^{16} ($2^{16} = 65536$) while the permissible value for the **Total measuring range** will be between 2 and 2^{30} ($2^{30} = 1073741824$).



NOTE

When you change the value next to this parameter, then you are required to enter a new preset.

Maximum Master Sign-Of-Life failures

With this parameter the number of allowed failures of the Master's sign of life is defined. The default value is one (1).
 Default = 1 (min. = 1, max. = 255)



NOTE

This parameter is only supported in compatibility mode (see **Compatibility mode** on page 93).

Velocity measuring units

This parameter defines the coding of the velocity measuring units used to configure the signals **NIST_A** and **NIST_B**. Standard telegram 81 has no velocity information included and the encoder does not use the velocity measuring unit information in this case. Standard telegrams 82, 83 and 84 include velocity output and need a declaration of the velocity measuring unit.

| Parameter | Meaning | Value |
|--------------------------|---|-----------------|
| Velocity measuring units | Definition of the units for the encoder velocity output value | See table below |

| Velocity measuring units | Value |
|--------------------------|-------|
| Steps / s | 0 |
| Steps / 100 ms | 1 |
| Steps / 10 ms | 2 |
| RPM | 3 |

Default = 0 (min. = 0, max. = 3)



NOTE

Please note that the velocity value is always calculated every 100 ms.

9.5 "Red Zone"

The so-called "Red Zone" problem occurs when the **Number of revolutions** (i.e. the **Total measuring range / Measuring units / Revolution**) is not a power of 2.

When this problem arises, the device must operate within the "red zone" for a certain number of positions. The size of the "red zone" is variable. To calculate it we must subtract the overall set resolution from the overall physical resolution of the device as many times as until the difference is less than the overall set resolution. When the encoder crosses the limit of the last value in the overall physical resolution, a counting error occurs, i.e. a jump in the position count. The problem is represented graphically in the following Figure.

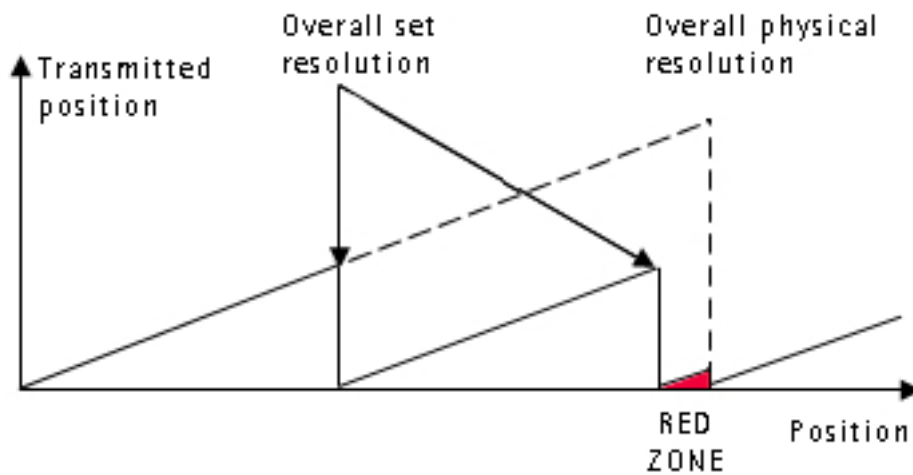

EXAMPLE

HM58 16/16384 PT multiturn encoder

Physical resolution:

- Singleturn physical resolution = 65536 counts/rev. = 16 bits (2^{16})
- Multiturn physical resolution = 16384 revolutions = 14 bits (2^{14})
- Overall physical resolution = 1073741824 = 30 bits (2^{30})

Set values:

- **Measuring units / Revolution** = 65536 = 2^{16}
- **Total measuring range** = 442236928 = it is NOT a power of 2

It results from this:

- **Number of revolutions** = 6748 = it is NOT a power of 2

This can be proved easily:

$$\frac{\text{Overall physical resolution}}{\text{Overall set resolution}} = \frac{1073741824}{442236928} = 2,427...$$

It follows that for 189267968 positions ($1073741824 - 442236928 * 2 = 189267968$), i.e. for 11552 revolutions, the encoder will work within the limits of the so-called "red zone". After position 189267968 (i.e. at the end of the "red zone") a position error (namely, a "jump" in the position count) would happen as the following position would be "0". See the Figure in the previous page.



NOTE

Make attention using the values sent by the encoder while working within the limits of the "Red Zone". When the encoder changes from normal status to "Red Zone" status (and vice versa) a jump of position occurs.

10 Diagnostics and Alarms

Diagnostics data is always transferred acyclically using Record Data communication over the non real time channel. A PN-IO controller can request diagnostic data from the PN-IO device using RDO (Record Data Object) services.

Alarm data is transmitted from the IO device to the IO controller via the RT channel.

The encoder errors are divided into **Faults** and **Warnings**, they are defined as follows.

FAULT

A Fault is set if a malfunction in the encoder could lead to incorrect position values.

WARNING

Warnings indicate that the tolerance for certain internal parameters of the encoder has been exceeded. Unlike faults, warnings do not imply incorrect position values.

NOTE

Please note that warnings are not supported in this encoder.



There are several diagnosis mechanisms that are used to monitor encoder diagnostics.

Please refer to the table below for an overview of the available diagnosis mechanisms.

| Function | Reference |
|--|-----------------|
| Acyclic diagnosis parameter P65001 - Operating status | See on page 100 |
| Channel related diagnosis via the Alarm Channel | See on page 100 |
| Error codes in G1_XIST2 | See on page 101 |
| LED indication | See on page 101 |

10.1 Acyclic diagnosis parameter P65001 – Operating status

With the Acyclic parameter **P65001 – Operating status** the current status of the Encoder Faults and Warnings as well as the support of the individual Fault and Warning bits can be read from the encoder. For detailed information on the parameter **P65001 – Operating status** please refer to page 87.

10.2 Error messages via the Alarm Channel

The encoder diagnosis is reported to the controller via the Alarm channel as Channel Related Diagnosis. Both warnings and faults are reported in the same manner but with different error types.



NOTE

In compatibility mode (see the parameter **Compatibility mode** on page 93), channel related diagnostics can be switched off by the **Alarm channel control** parameter, please refer to its description on page 92.

For a detailed definition of the use of the channel related diagnosis please refer to the Alarm mechanism definition for the respective communication system in the mapping part of the profile.

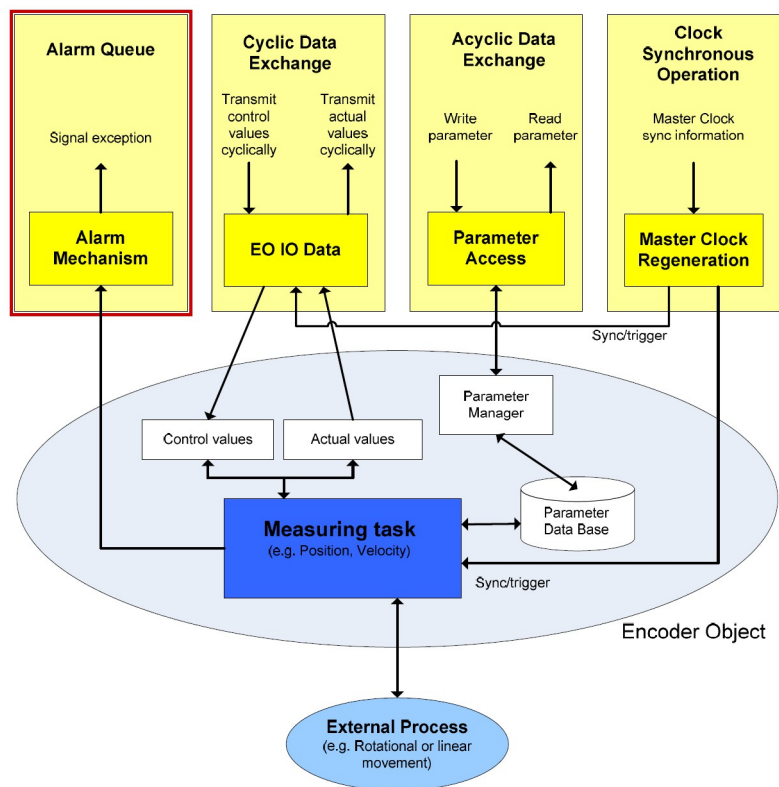

10.2.1 Use of the ChannelErrorType

For Profinet the encoder faults and warnings are mapped to the ChannelErrorTypes defined in the PROFdrive profile, see the tables below. This means that there are no specific codes defined for standalone encoders and a PROFINET controller will interpret the errors from an encoder in the same ways as an error coming from a drive. Refer also to the parameter **P65001 – Operating status** on page 87.

| Error type | Definition | Explanation |
|------------|---------------------------------|---|
| 0x9000 | Memory error | The encoder failed to read saved offset or preset values from the internal non volatile memory. |
| 0x9011 | Commissioning diagnostic | User parameter data assignment error. |

10.3 Error codes in G1_XIST2

Error codes are sent in **G1_XIST2** if an error occurs. For information about **G1_XIST2** refer to page 76.

| G1_XIST2 | Meaning | Explanation |
|----------|------------------------------------|--|
| 0x0F02 | Master's sign of life fault | The number of permissible failures of the master's sign of life was exceeded. |
| 0x0F04 | Synchronization fault | The number of permissible failures for the bus cycle was exceeded. |
| 0x1001 | Memory error | Error while writing on or reading the internal non volatile memory. |
| 0x1002 | Parametrization error | User parameter data assignment error. Example: Measuring units / Revolution and Total measuring range not compatible. |

10.4 LED indication

Errors are further indicated through LEDs. Six LEDs located in the cap of the encoder (see Figure 1) are meant to show visually the operating or fault status of the encoder and the Profinet interface.

For detailed information refer to the "4.6 Diagnostic LEDs (Figure 1)" section on page 32.

11 Real time class communication

Within PROFINET IO, process data and alarms are always transmitted in real time. Real-Time for PROFINET (RT) is based on the definitions of IEEE and IEC for high-performance data exchange of I/O data. RT communication constitutes the basis for data exchange in PROFINET IO.

Real-time data are handled with higher priority compared to TCP(UDP)/IP data. This method of data exchange allows bus cycle times in the range of a few hundred milliseconds to be achieved.

Isochronous data exchange with PROFINET is defined in the Isochronous-Real-Time (IRT) concept. IRT communication is always clock synchronized and only possible within an IRT domain. Isochronous real-time communication differs from real-time communication mainly in its isochronous behaviour: the start of a bus cycle can deviate by a maximum of 1 μ s (jitter is less than 1 μ s). IRT is required in motion control applications (positioning operations), for example. This communication is required, for example, for high-accuracy closed-loop control tasks.

11.1 Real-time classes in PROFINET IO

To enable enhanced scaling of communication options and, thus, also of determinism in PROFINET IO, real-time classes have been defined for data exchange. From the user perspective, these classes involve unsynchronized and synchronized communication.

PROFINET IO differentiates the following classes for RT communication. They differ not in terms of performance but in determinism.

11.2 Real-Time class 2 (RT2) – Not synchronized

In real-time class 2 frames are transmitted via unsynchronized communication (anysochronous communication).

To activate the real-time class 2 both the IO controller and the IO device must be set exactly the same as "Not synchronized". To do this proceed as follows.

11.2.1 Setting an anisochronous communication

To configure the IO controller (Figure 35) double click the **PN-IO** slot X2 to open the PN-IO properties dialog box. The **Properties – PN-IO** property sheet will appear. Enter the **Synchronization** tabbed page and select the **Not synchronized** value in the drop-down menu of the **Synchronization role** item. Confirm pressing the **OK** button.

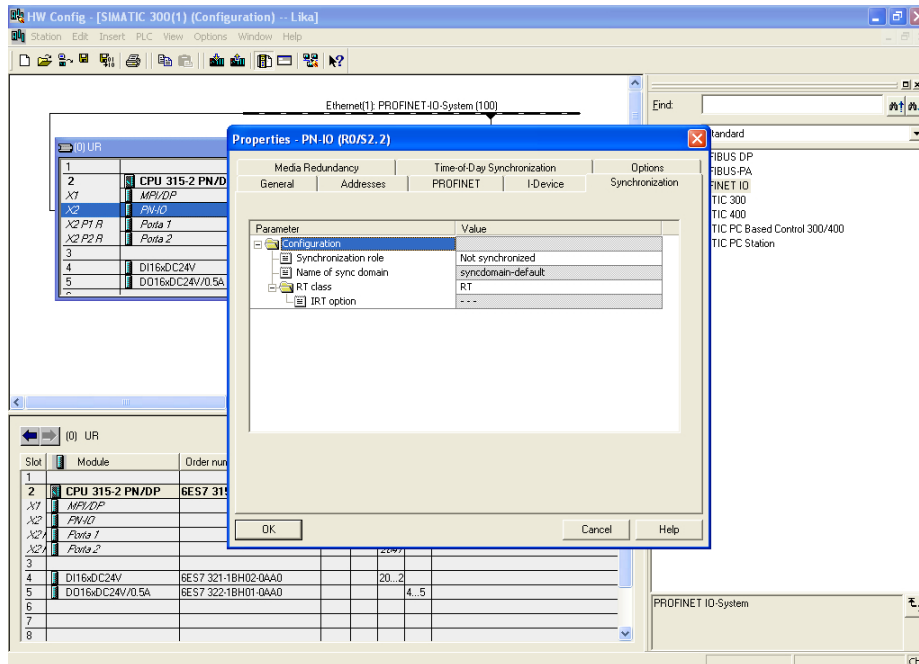

Figure 35 - Setting the Not synchronized role of the IO controller

To configure the IO device (Figure 36) double click the **Interface** slot X1 of the module to open the interface properties dialog box. The **Properties – Interface** property sheet will appear. Enter the **Synchronization** tabbed page and select the **Not synchronized** value in the drop-down menu of the **Synchronization role** item. Confirm pressing the **OK** button.

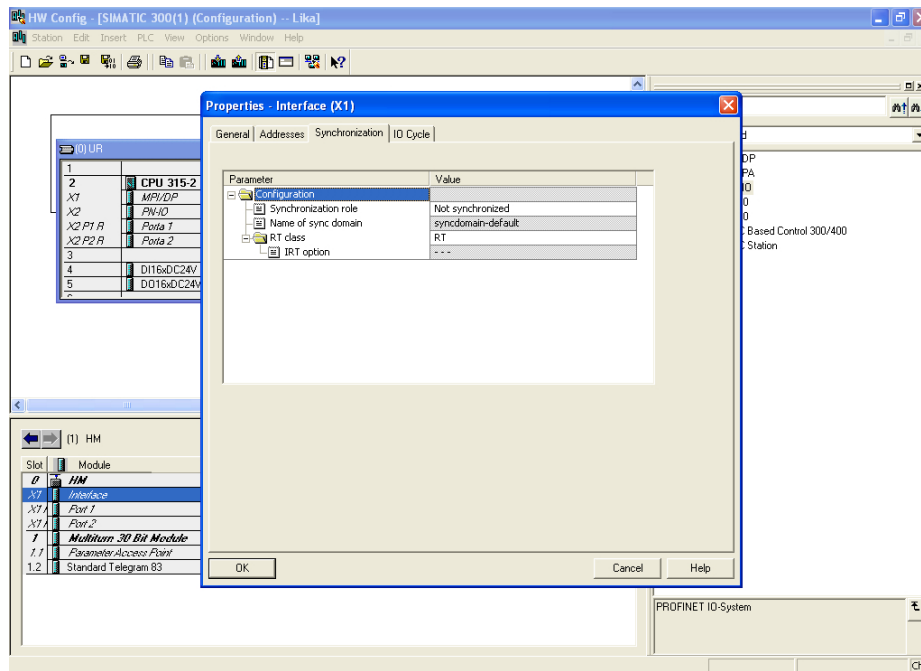

Figure 36 - Setting the Not synchronized role of the IO device

11.3 Real-Time class 3 (IRT_TOP) (RT3)

Isochronous data exchange with PROFINET is defined in the Isochronous-Real-Time (IRT) concept. IRT communication is always clock synchronized and only possible within an IRT domain. Isochronous real-time communication differs from real-time communication mainly in its isochronous behaviour: the start of a bus cycle can deviate by a maximum of 1 μ s (jitter is less than 1 μ s).

This communication is required, for example, for high-accuracy closed-loop control tasks.

Only industrial IRT switches can be used.

Typical cycle time 1 ms or less. All network components must support PROFINET IRT frame priority processing. Position values are captured with an accuracy of +/- 1 μ s or better, with respect to the highly accurate bus clock.

11.3.1 Setting an isochronous communication

To activate the real-time class 3 both the IO controller and the IO device must be configured. To do this proceed as follows.

To configure the IO controller (Figure 37) double click the **PN-IO** slot X2 to open the PN-IO properties dialog box. The **Properties – PN-IO** property sheet will appear. Enter the **Synchronization** tabbed page and select the **Sync master** value in the drop-down menu of the **Synchronization role** item; select the **High performance** value in the drop-down menu of the **IRT option** item. Confirm pressing the **OK** button.

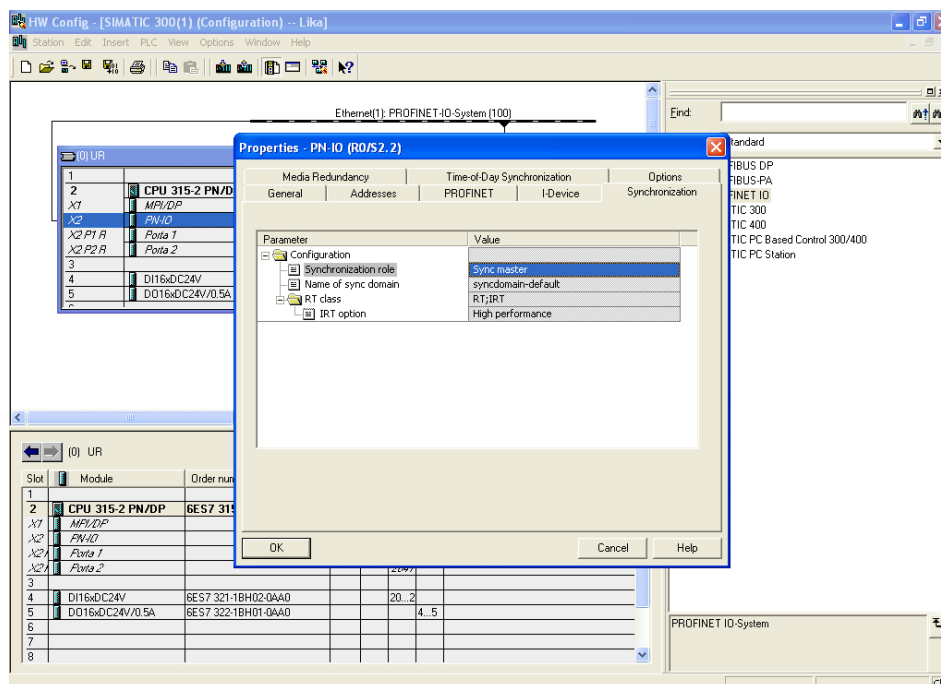

Figure 37 - Setting the sync master role of the IO controller

To configure the IO device (Figure 36) double click the **Interface** slot X1 of the module to open the interface properties dialog box. The **Properties – Interface** property sheet will appear. Enter the **Synchronization** tabbed page and select the **Sync slave** value in the drop-down menu of the **Synchronization role** item; select the **High performance** value in the drop-down menu of the **IRT option** item. Confirm pressing the **OK** button.

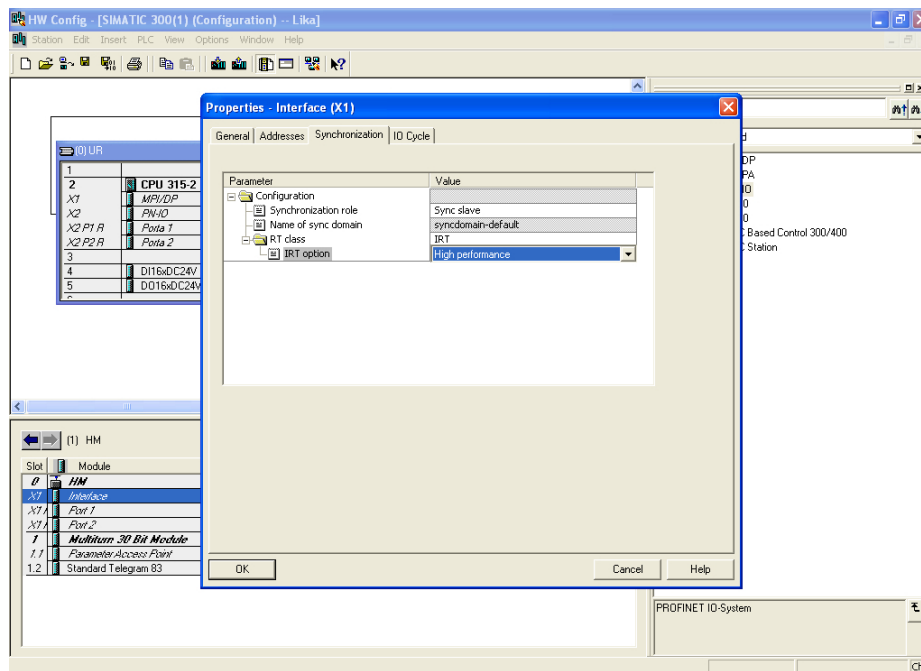

Figure 38 - Setting the sync slave role of the IO device

Now double click the **CPU** slot 2 in the CPU configuration table to open the CPU properties dialog box. The **Properties – CPU 315 ...** property sheet will appear. Enter the **Synchronous Cycle Interrupts** tabbed page and press the **Details** button.

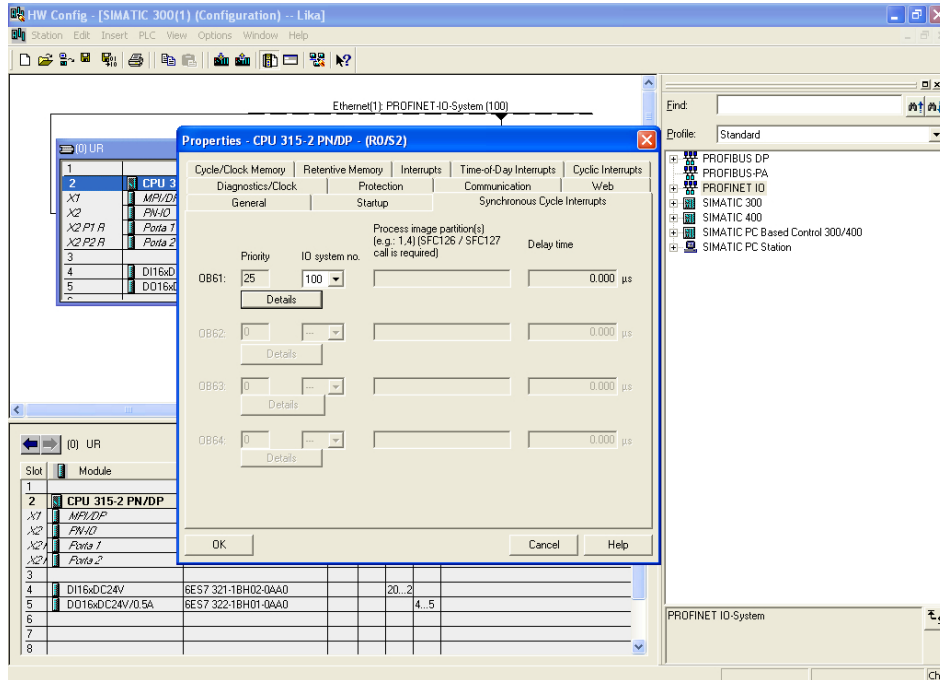

Figure 39 – CPU property sheet

The **OB61** dialog box will appear on the screen. Set the value "1" next to the **Process image partition(s)** item. Confirm pressing the **OK** button.



NOTE

For more information on PIPs (Process Image Partitions) refer to the "11.5 PIP (Process Image Partition)" section on page 117.

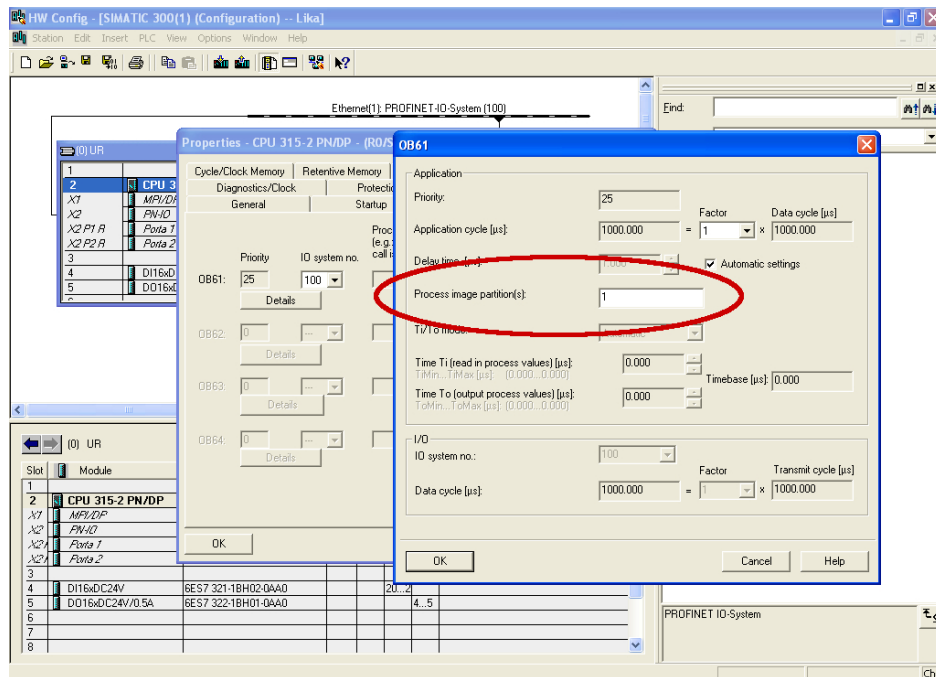

Figure 40 - PIP of OB61

Now set the encoder in isochronous mode. To do this double click the **Interface** slot X1 of the module to open the interface properties dialog box. The **Properties – Interface** property sheet will appear. Enter the **IO cycle** tabbed page and select the **OB61** value in the drop-down menu of the **Assign IO device in isochronous mode** item. For further information see also the "11.4 OB61" section on page 116.

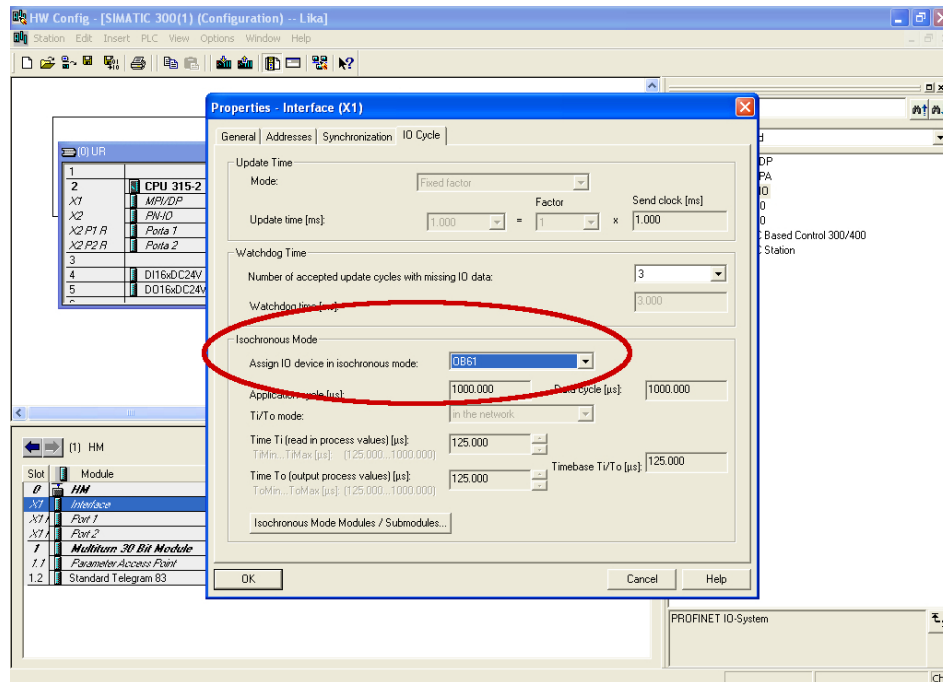

Figure 41 – OB61: assigning IO device in isochronous mode

Press the **Isynchronous Mode Modules / Submodules ...** button below in the **Properties – Interface** property sheet and enter the **Isynchronous Modules / Submodules** dialog box. Check that an isochronous submodule has been installed (Standard Telegram 83 in the example). Confirm pressing the **OK** button.

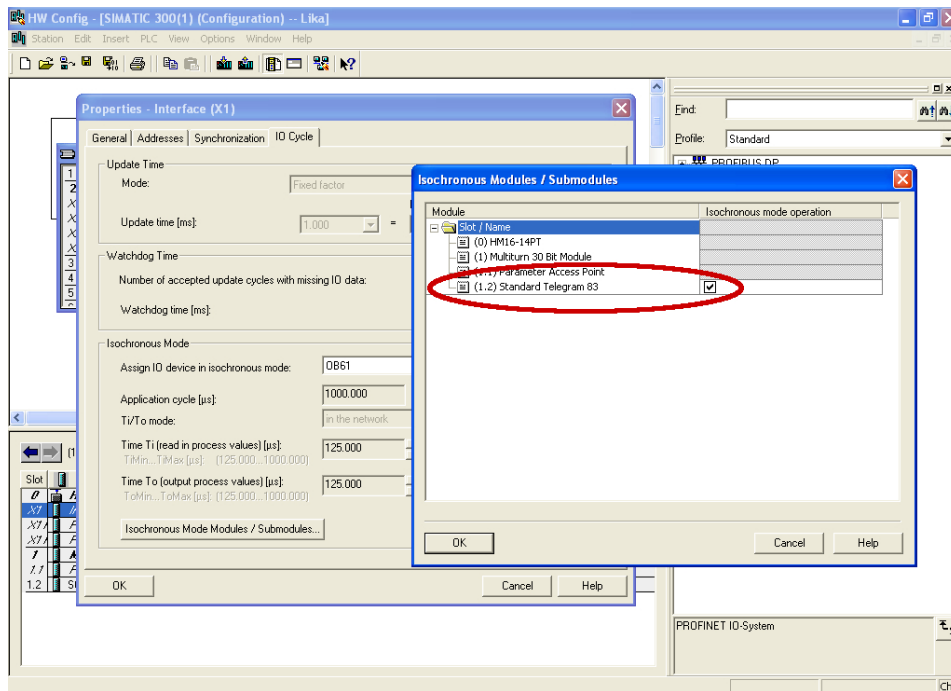

Figure 42 – Standard Telegram as isochronous submodule

Double click the **Standard Telegram** slot 1.2 of the module to open the telegrams properties dialog box. The **Properties – Standard Telegram** property sheet will appear. Enter the **Addresses** tabbed page and set the process image of the isochronous submodule as **PIP 1**. Select the **PIP1** value in the drop-down menu of the **Process image** items in both **Inputs** and **Outputs** group boxes. Confirm pressing the **OK** button.



NOTE

For more information on PIPs (Process Image Partitions) refer to the section "11.5 PIP (Process Image Partition)" on page 117.

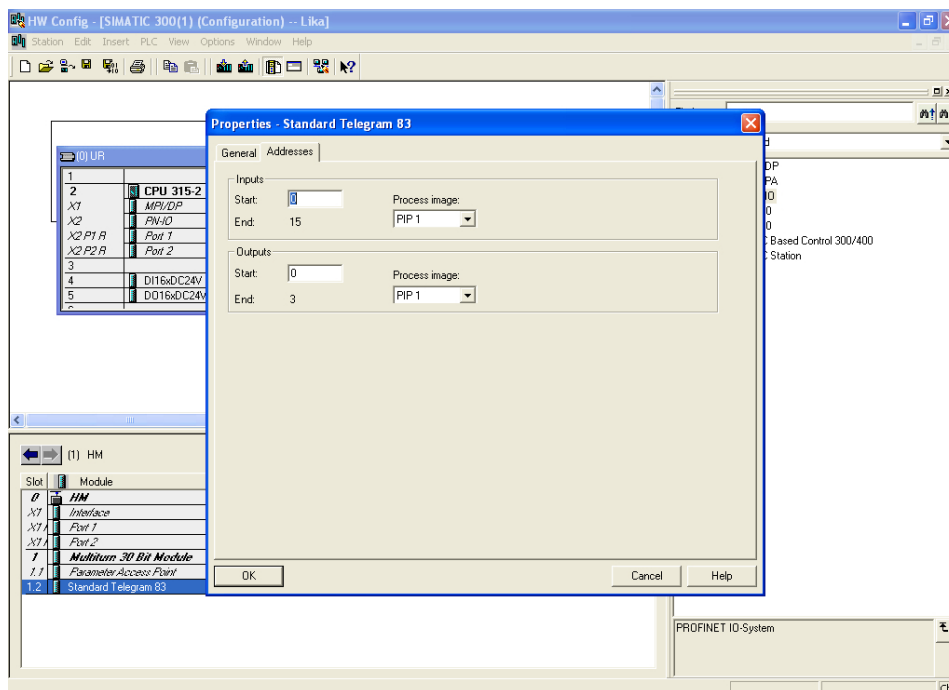

Figure 43 - Setting PIP for Standard Telegram IOs

Now you need to set a connection between the port of the controller and the port of the encoder. Please check the specific configuration of your Profinet network. In the example the port 2 of the IO controller is connected to the port 1 of the IO device; see Figure 56.

So, first configure the IO controller and set its port 2 to be connected to the port 1 of the IO device. Double click the **X2 P2 R PORT 2** slot in the CPU configuration table and open the Port 2 properties dialog box. The **Properties – PN-IO – Port 2** property sheet will appear. Enter the **Topology** tabbed page and set the **Port 1 (X1 P1)** value in the drop-down menu in the **Partner port** item of the **Partners** group box. Confirm pressing the **OK** button.

Refer also to the "11.7 Topology Editor" section on page 123.

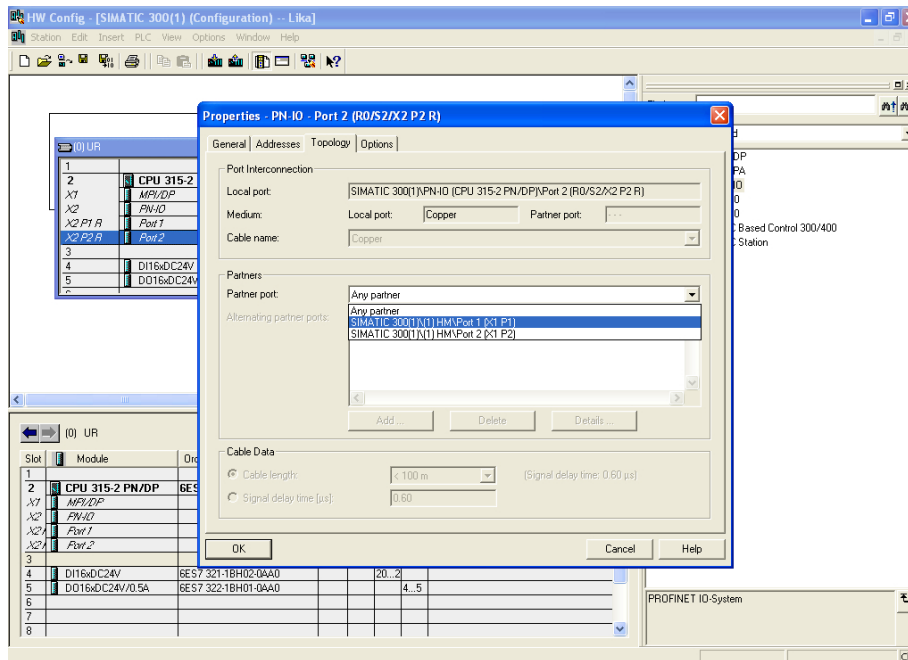

Figure 44- Configuring the IO controller topology

Then configure the IO device and set its port 1 to be connected to the port 2 of the IO controller. Double click the **X1 P1 PORT 1** slot in the Device configuration table and open the Port 1 properties dialog box. The **Properties – Interface – Port 1** property sheet will appear. Enter the **Topology** tabbed page and set the **Port 2 (X2 P2 R)** value in the drop-down menu in the **Partner port** item of the **Partners** group box. Confirm pressing the **OK** button.

Refer also to the "11.7 Topology Editor" section on page 123.

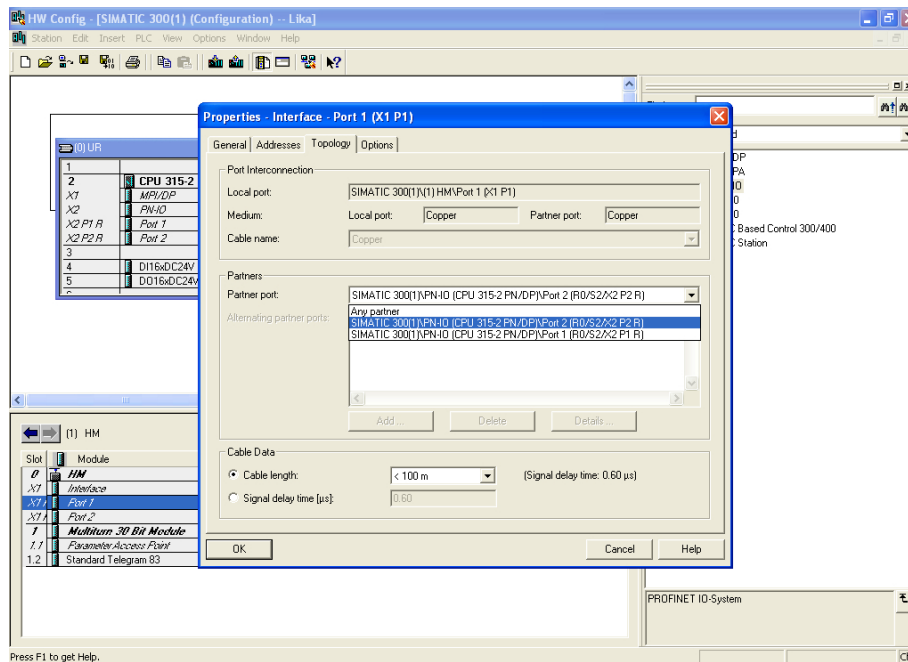

Figure 45 – Configuring the IO device topology

Finally check the Profinet IO isochronous mode.

Right click the **2 CPU** slot in the CPU configuration table and press the **PROFINET IO Isochronous mode** command.

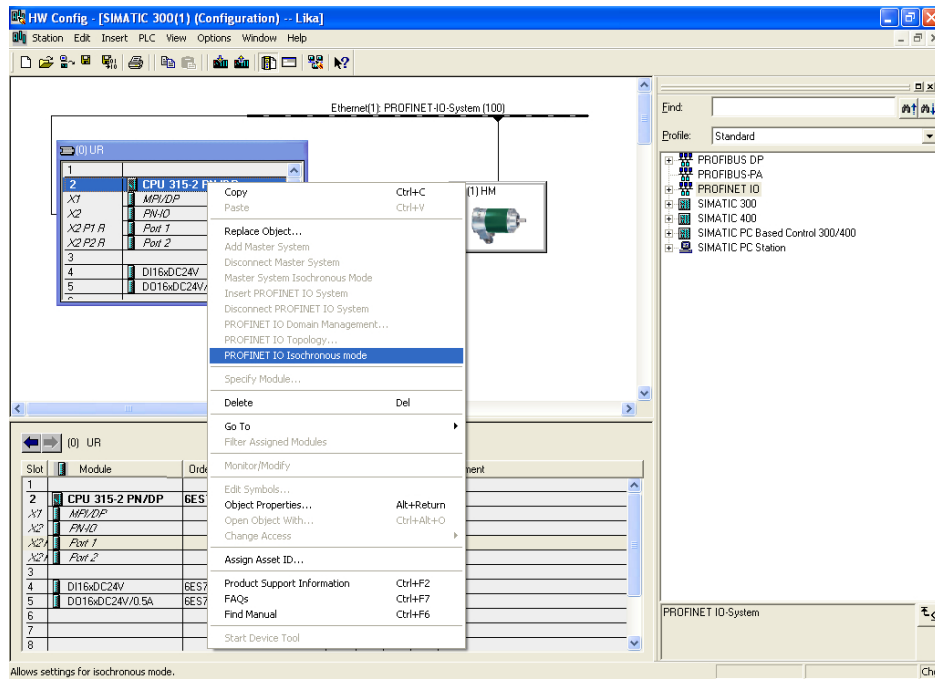

Figure 46 - Checking the Profinet IO isochronous mode

The **Isochronous Mode** dialog box will appear on the screen. The installed Standard Telegram is the only submodule which provides IO data. In this page you can check which IO devices / modules / submodules have been set in isochronous mode with the IO controller.

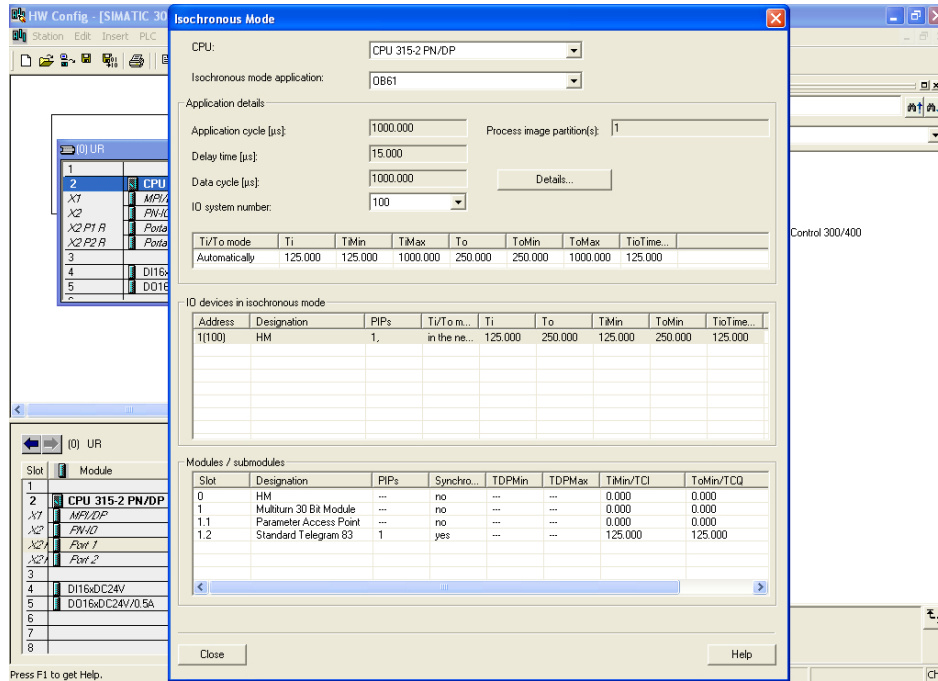

Figure 47 - Isochronous Mode dialog box

11.4 OB61



WARNING

Use of OBs requires both in-depth skills and specific expertise in SIMATIC STEP 7 programming environment. For detailed information please consult the STEP 7 Programmer's handbook and documentation.

Organization blocks (OBs) form the interface between the CPU operating system and the user program. The order in which the user program is executed is defined in the organization blocks.

The synchronization with the user program is maintained through the clocked interrupt OB61. OB61 is a synchronous cycle interrupt; in other words it is an isochronous event that is called with the start of every PROFINET cycle. It is synchronous with the Profinet send clock.

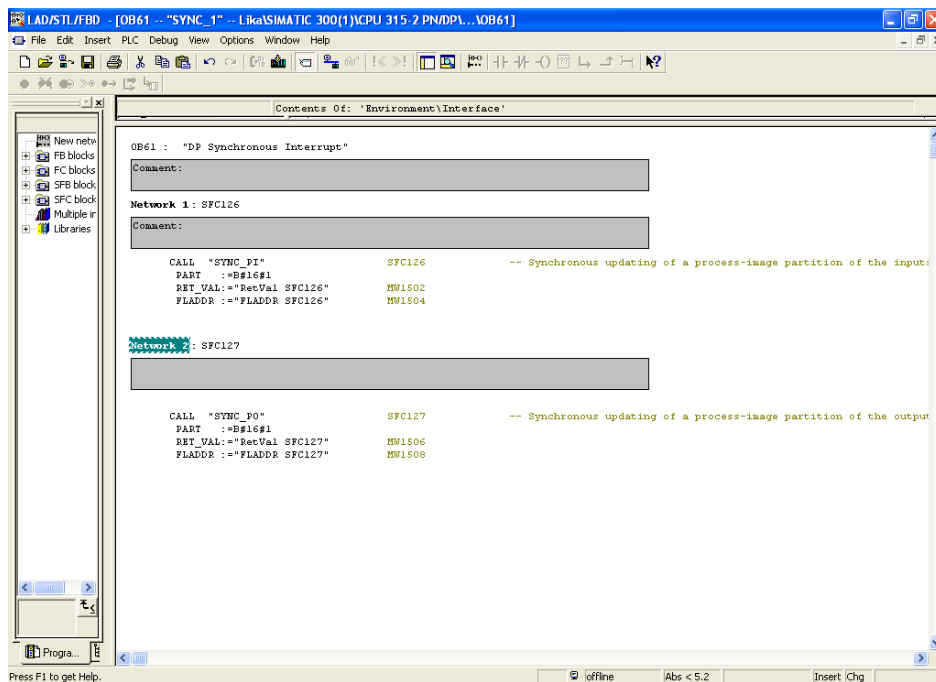

Figure 48 – OB61

11.5 PIP (Process Image Partition)



WARNING

Use of PIPs requires both in-depth skills and specific expertise in SIMATIC STEP 7 programming environment. For detailed information please consult the STEP 7 Programmer's handbook and documentation.

11.5.1 Consistency

PIPs (Process Image Partitions) are used to update the distributed IO device synchronously with the constant bus cycle time clock.

Compared with direct access to the input/output modules, the main advantage of accessing the process image is that the CPU has a consistent image of the process signals for the duration of one program cycle. If a signal state on an input module changes while the program is being executed, the signal state in the process image is retained until the process image is updated again in the next cycle. The process of repeatedly scanning an input signal within a user program ensures that consistent input information is always available. You define process image partition with STEP 7 when you assign addresses (which input/output addresses of the modules are listed in which process-image partition). The process image partition is updated by the user with SFCs.

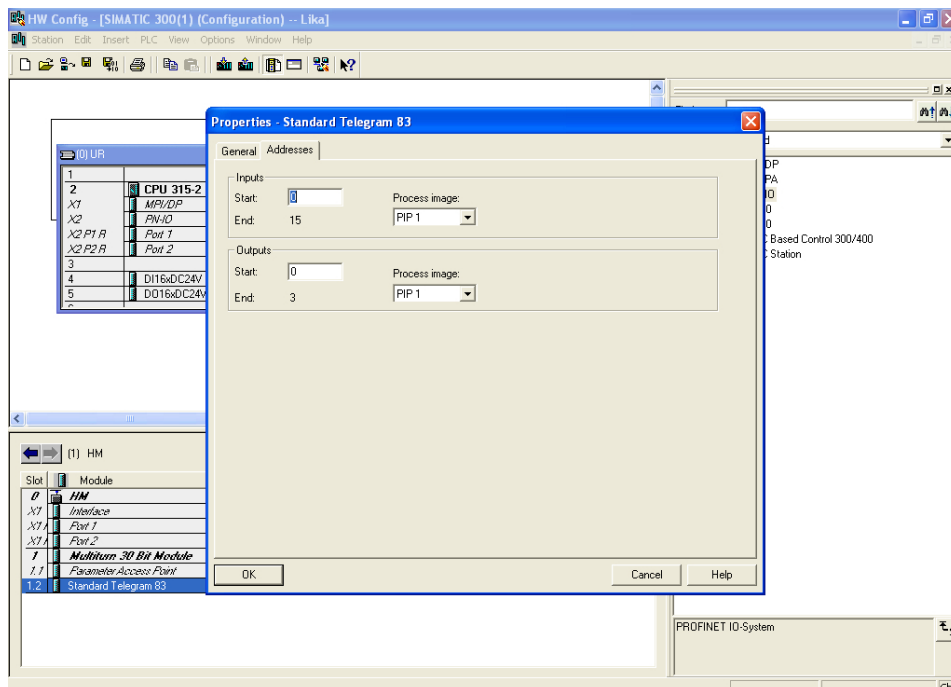

Figure 49 – Process Image Partition

The assigned process image partitions must be updated in the synchronous cycle interrupt OB61 at the call of the functions SFC126 "SYNC_PI" and SFC127 "SYNC_PO". The call of the function SFC126 "SYNC_PI" updates the process image partition input table; the call of the function SFC127 "SYNC_PO" updates the process image partition output table. So cyclic interrupt OB61 works with consistent image of the process signals. Refer also to page 111.

11.5.2 SFC126 "SYNC_PI"

This special function is used to update a process image partition input table in a synchronous cycle. Synchronous cycle interrupt OB61 calls the function SFC126 "SYNC_PI" to consistently and synchronously update the input data located in a process image partition.

11.5.3 SFC127 "SYNC_PO"

This special function update a process image partition output table in a synchronous cycle. Synchronous cycle interrupt OB61 calls the function SFC127 "SYNC_PO" to synchronously update the output data located in a process image partition and consistently transmit them to the encoder.

11.6 Domain Management



WARNING

The configuration of the Sync domain requires both in-depth skills and specific expertise in SIMATIC STEP 7 programming environment. For detailed information please consult the STEP 7 Programmer's handbook and documentation.

In the case of PROFINET IO with IRT, a sync master transmits a synchronization message to which all sync slaves synchronize themselves. The synchronization mechanisms will be controlled by ERTEC (Enhanced Real-Time Ethernet Controller) of the integrated PROFINET interface. This ensures a synchronization accuracy of less than one microsecond. The synchronization of all IRT-capable PROFINET devices on a common time base is the prerequisite for the scheduled communication control and the bandwidth reservation.

You assign the device roles sync master and sync slave by configuring the PROFINET devices in STEP 7, as described below. The role of a sync master can be assigned both to an IO controller as well as a switched configured on an IO device, provided these support the "sync master" function.

The sync master and the sync slaves together form the sync domain. A sync domain has exactly one active sync master - for the runtime.

It is mandatory that all PROFINET devices that are to be synchronized via PROFINET IO with IRT must belong to a sync domain. The sync domain consists of precisely one sync master and at least one sync slave. IO controllers and switches can hold the role of a sync master or sync slave. Other IO devices support only the role as sync slave. An IRT Class 3 Device must be member of a sync domain too. The properties of the sync domain must be set in the dialog boxes described in this section, especially the cycle time of the send clock. Only those values may be entered which are common to both the Master and all devices on the bus.

To assign the IO device to a sync domain select and right-click the **Profinet-IO system** in the **HW Config** window. Press the **PROFINET IO Domain Management...** command in the shortcut menu.

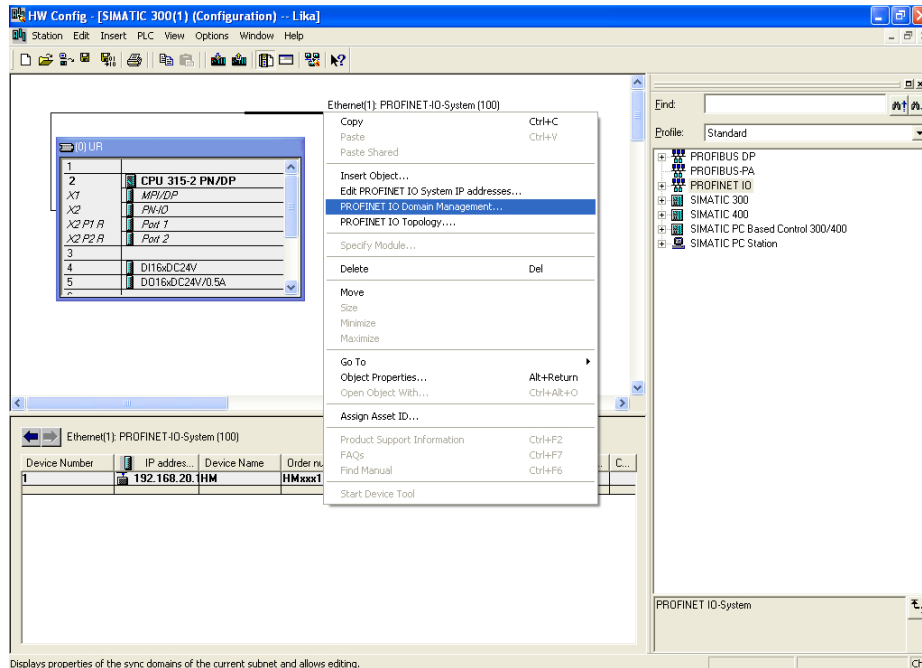

Figure 50 - Assigning the IO device to a sync domain

The **Domain Management** dialog box will appear on the screen. Using the **Domain management** dialog box you can check the settings of the PROFINET IO system.

The name of the sync domain is automatically assigned by STEP 7 with "syncdomain-default" when the first sync domain is configured. You find it under the **Sync domain** item in the **Sync domain** group box. Alternatively you can create further sync domains.

The **Send clock time (ms)** is the period between two successive intervals for IRT or RT communication. The send clock is the shortest possible transmit interval for exchanging data. You have the option to establish the send clock for your sync domain in order to achieve an optimum coordination of the transmission bandwidth to the data volume. Depending on the PROFINET devices of the respective PROFINET IO systems, STEP 7 calculates the possible values that can be set. Select one of the default send clock time values in the drop-down list.

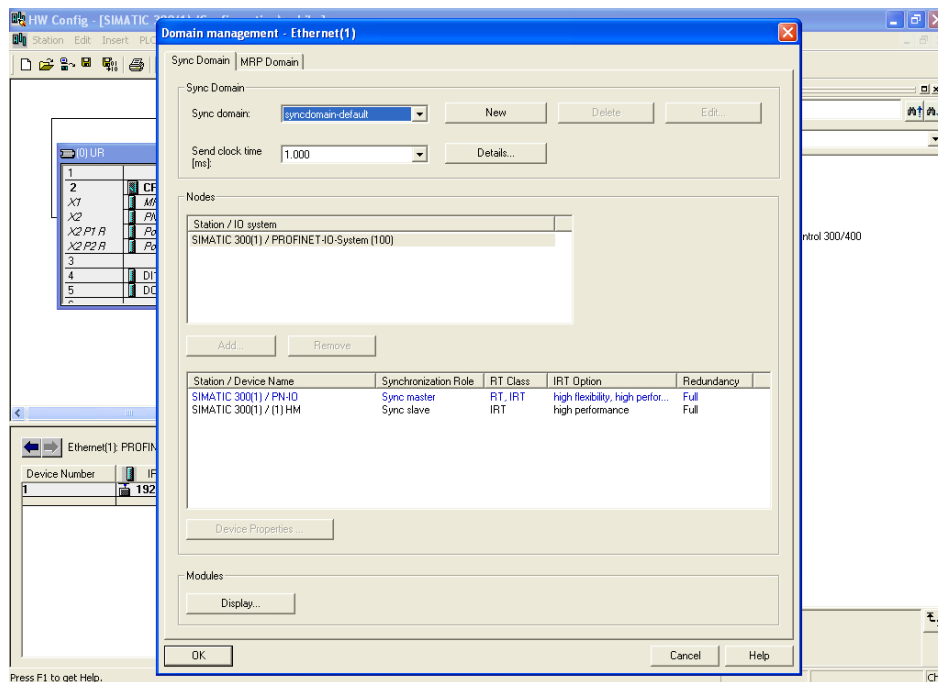

Figure 51 - Domain management dialog box

You have the option of establishing the reserved transmission bandwidth for IRT data as a proportion of the maximum reservable transmission bandwidth for cyclic user data communication. The proportion is specified in percent (%). In doing so, the maximum transmission bandwidth set by the system for cyclic data may not be exceeded by the reserved transmission bandwidth for IRT plus the transmission bandwidth that is required for the cyclic data in the free transmission bandwidth (RT communication).

Press the **Details...** button in the **Domain Management** dialog box. The **Details – Sync domain** dialog box will appear on the screen. In the **Upper limit for IRT** drop-down list available in the **Cyclic data** group box, select one of the default values (in %). STEP 7 offers the following selections: 0, 10, ... 100.

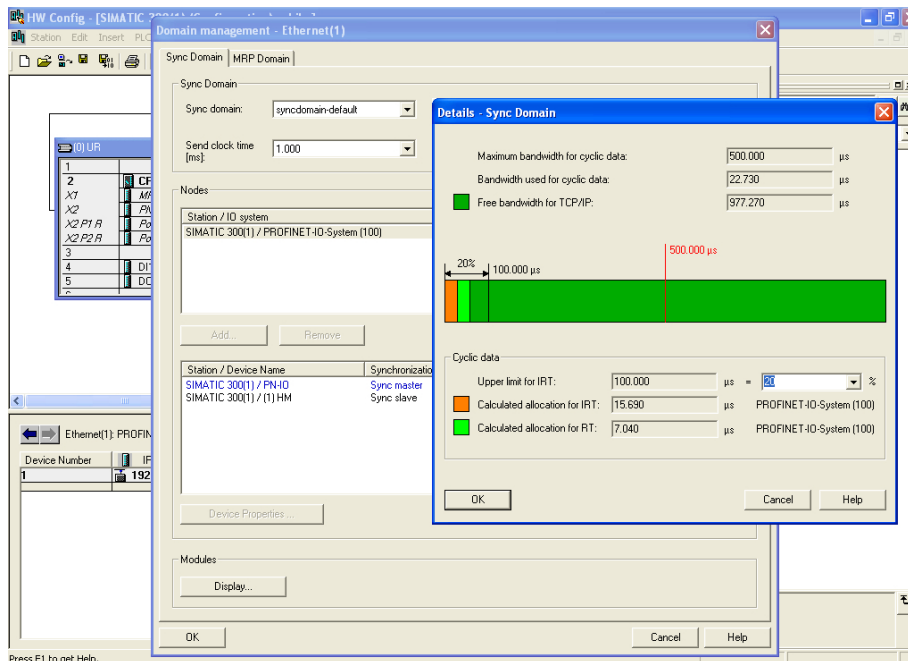

Figure 52 – Sync domain details dialog box

The PROFINET IO system of the sync domain is established now on a send clock. Save the settings and close both the **Details – Sync Domain** and the **Domain management** dialog boxes pressing the **OK** button. Finally save, compile and then download the configuration to the controller.

11.7 Topology Editor

Using the **Topology Editor** you can topologically configure your PROFINET IO system. The topology editor has a series of functions for setting, interconnecting and diagnosing the properties of all PROFINET devices including their ports. So it supports you in the following tasks:

- obtaining topology information about all ports of the PROFINET devices in the project;
- configuring the set topology on PROFINET by interconnecting the interfaces and ports by simply dragging and dropping and establishing properties.

Enter the **Topology Editor** dialog box to edit the topology of your Profinet-IO System. To do so select and right-click the **Profinet-IO system** in the **HW Config** window and then press the **PROFINET IO Topology...** command in the shortcut menu.

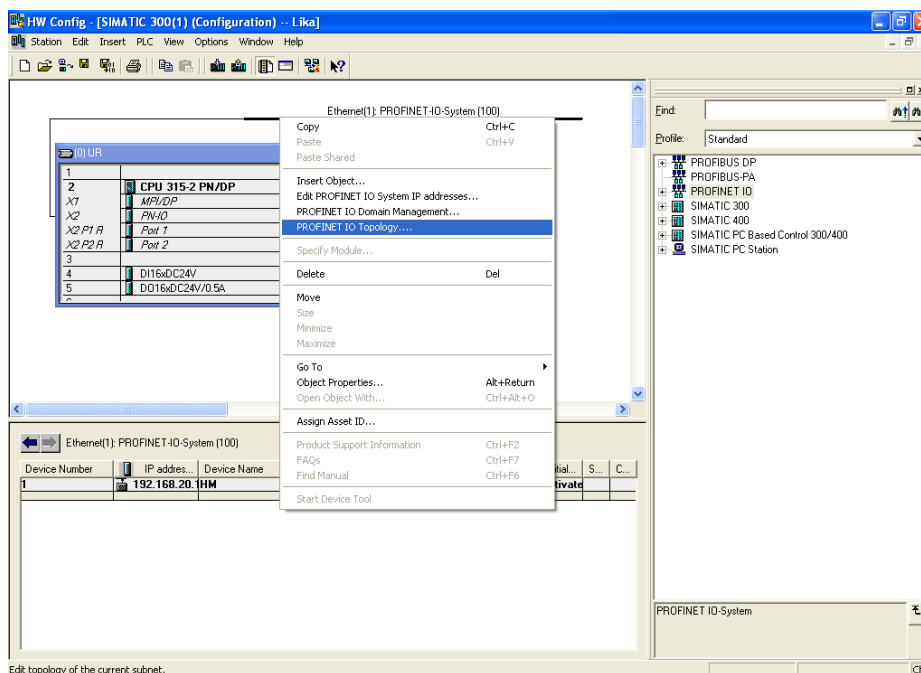

Figure 53 - Entering the Topology Editor

The **Topology Editor** dialog box will appear on the screen. As the PROFINET IO system has already been set up and the PROFINET devices connected (to connect the port of the IO controller and the port of the IO device see on page 112), they do not need to be first of all interconnected to a topology within the project. So in the **Table view** tabbed page you will see the configured PROFINET devices and ports currently connected in the system. The **Interconnection table** in the left area of the page lists all the configured PROFINET devices with their ports. The **Selection range** group box in the top right section lists all the PROFINET devices that are available for the topological interconnection.

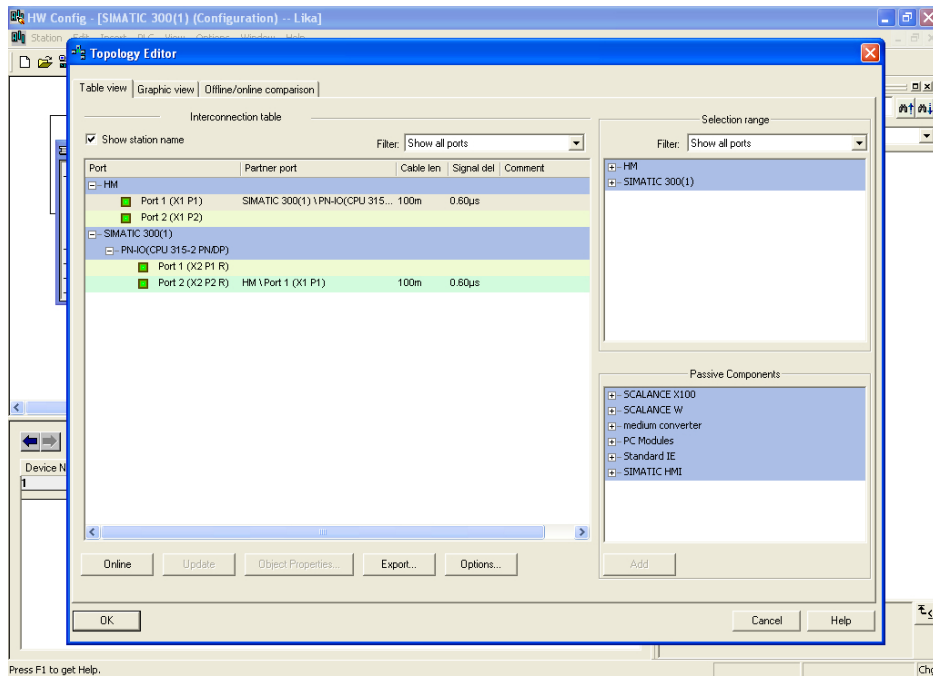

Figure 54 – Topology Editor: Table view

The **Offline/online comparison** tabbed page lists the configured PROFINET devices with their interfaces and ports and the associated neighbour ports in the left box **Configured topology (offline)**. The right box **Detected topology (online)** shows the online view of the PROFINET IO system with its interconnection for the runtime. Press the **START** button above in the box to import the PROFINET devices of your project.

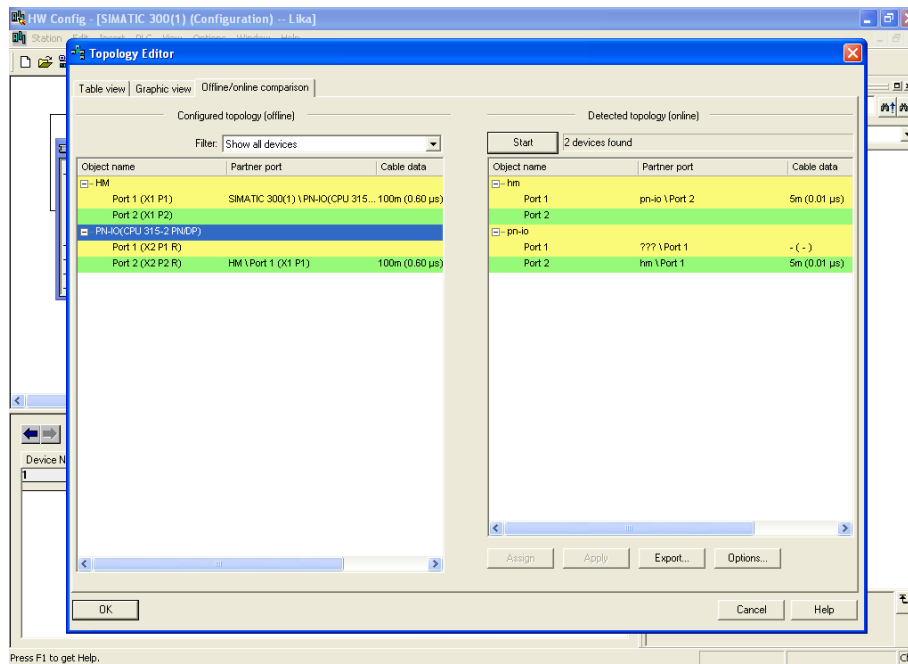

Figure 55 - Topology Editor: Offline/Online comparison

The **Graphic view** tabbed page displays the PROFINET devices in the project and their interconnections.

In the **Miniature View** in the top right section, you can use the slider to select the section of the PROFINET IO system and its enlargement factor. To change the section of the PROFINET IO system, use the mouse to drag the frame across the desired area that you wish to see in detail.

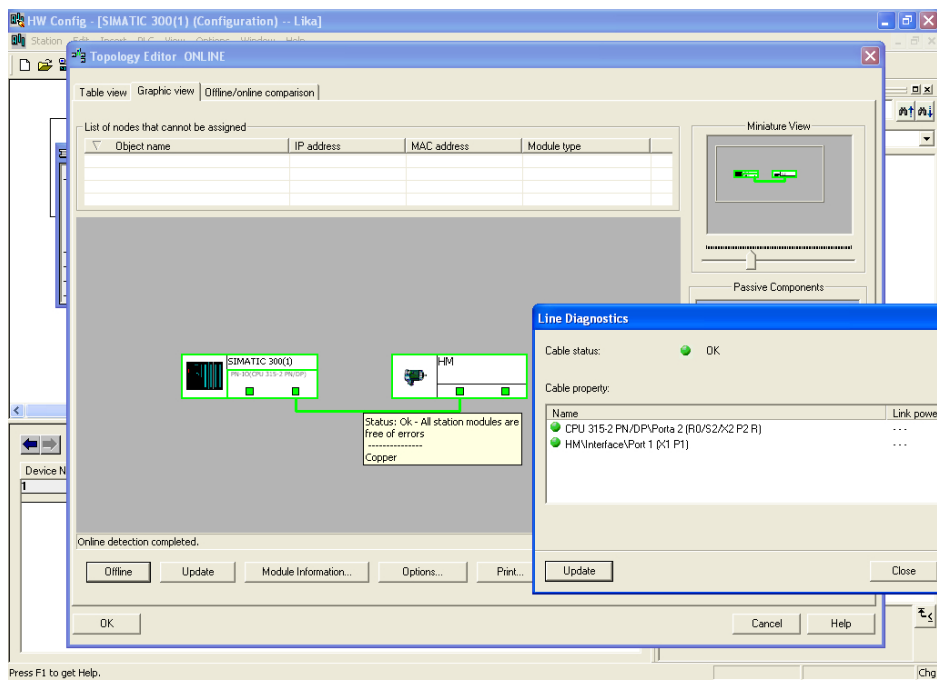

Figure 56 – Topology Editor: Graphic view

Save the settings and close the **Topology Editor** dialog page by pressing the **OK** button.

11.8 Message monitoring

Below is an example of traffic between the IO controller and the IO device in IRT mode.

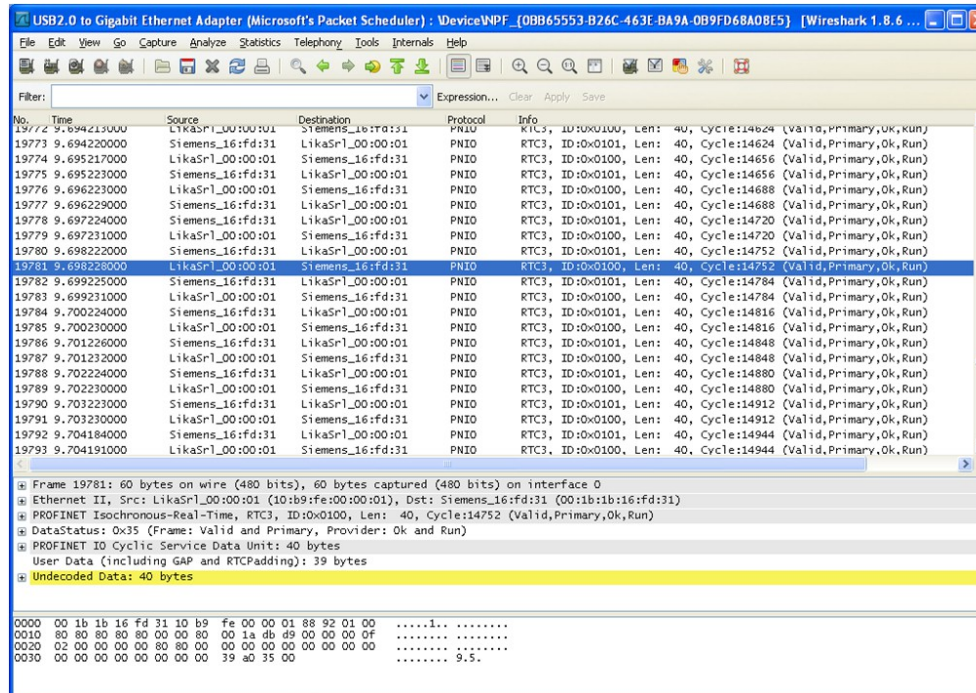

Figure 57 – Message monitoring

12 Encoder replacement using LLDP

LLDP (Link Layer Discovery Protocol) is a Layer 2 protocol that is used to detect the closest neighbours in the network. It enables a device to send information about itself and to save information received from neighbouring devices, i.e. it provides the option of communicating data between neighbouring devices (e.g. device name, port, MAC address). This information allows a network management system to determine the network topology. The protocol is formally referred to by the IEEE as *Station and Media Access Control Connectivity Discovery* specified in standards document IEEE 802.1AB.

Among the main uses, LLDP allows to replace a device of the Profinet network. The partner ports before and behind the replaced device save the relevant information so that no additional configuration is necessary. The flag **Support device replacement without exchangeable medium** must be activated in the Controller.

To activate / deactivate the function double click the **PN-IO** slot X2 to open the PN-IO properties dialog box. The **Properties – PN-IO** property sheet will appear. Enter the **General** tabbed page to find the **Support device replacement without exchangeable medium** check box. Please note that the **Support device replacement without exchangeable medium** function is activated by default in the IO controller.

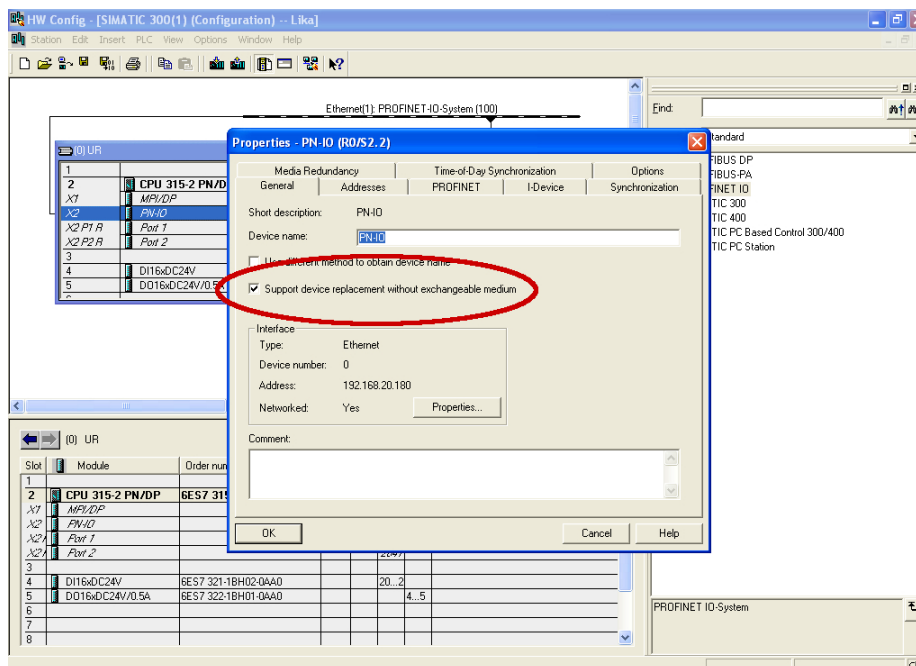
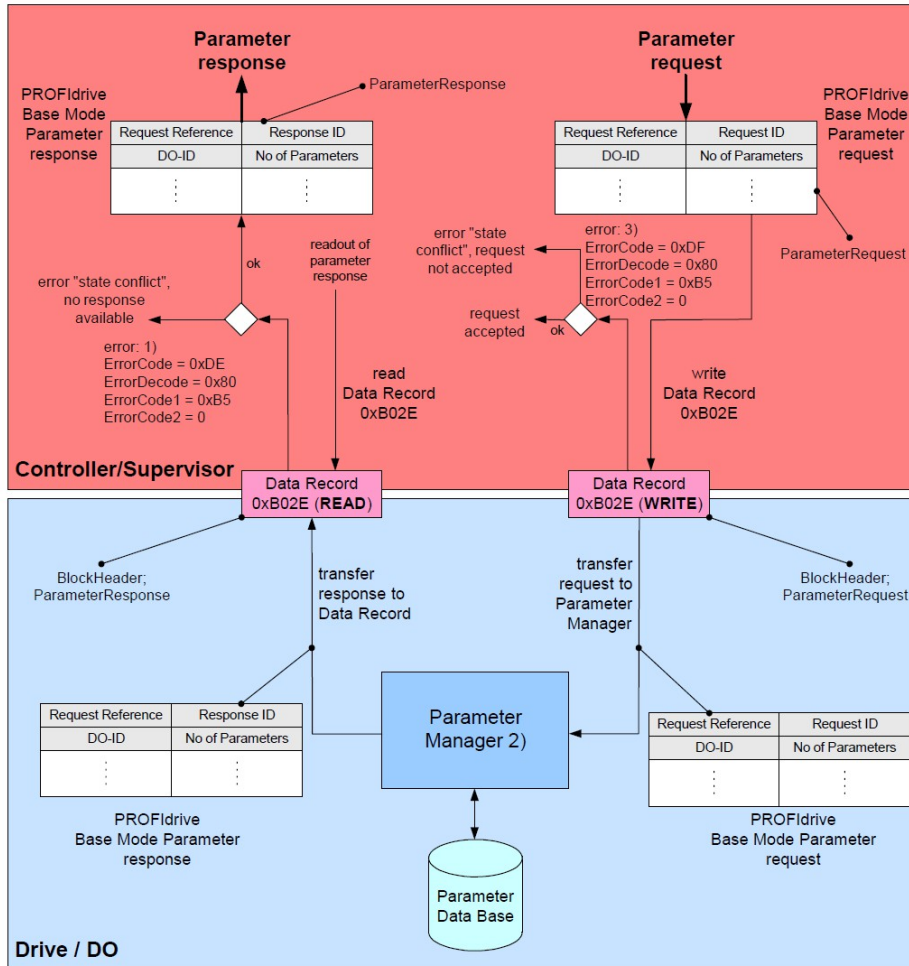

Figure 58 – Link Layer Discovery Protocol (LLDP)

**NOTE**

When you replace a device, make sure that the PROFINET cable is then inserted into the correct port as it is configured in STEP 7. Otherwise, the system will not run.

13 Read & write in acyclic comm



- 1) Error because the parameter manager is busy but not finished with the processing yet, or the parameter manager is idle
- 2) Processing of only one parameter requests per connection. Multiple connections cause multiple state machines for the processing each for every connection
- 3) Also error 0xB0 may be used if there is no PAP available and error 0xB7 if there is an error in the request header

Figure 59 - Base mode parameter request and response

13.1 Example: reading and writing a parameter (Preset Value)

13.1.1 System Function Block 52 (SFB52)

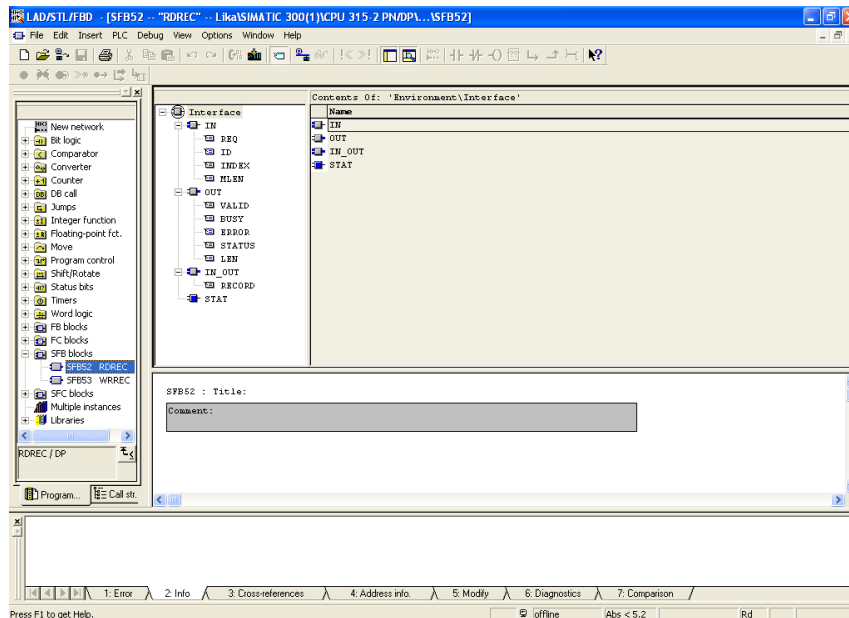

Figure 60 - SFB52

13.1.2 System Function Block 53 (SFB53)

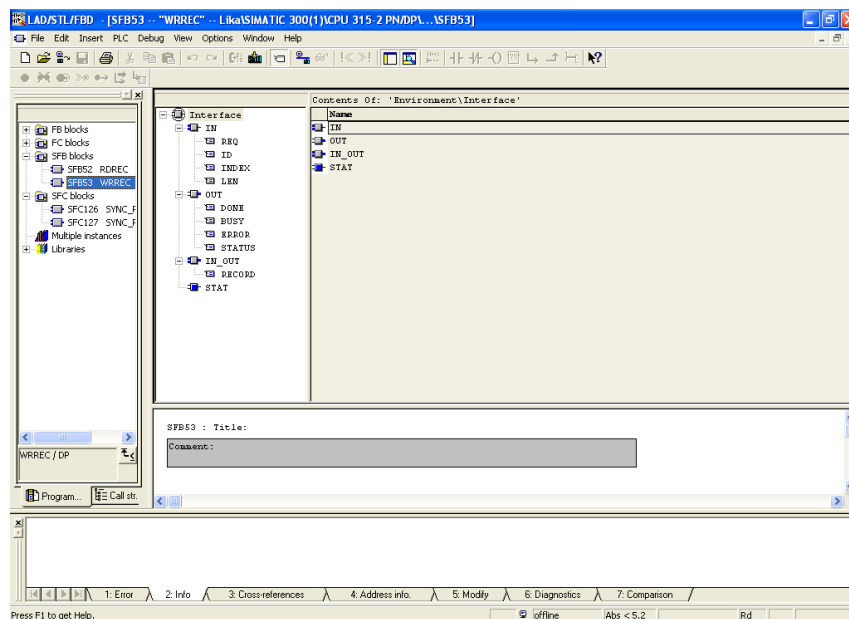

Figure 61 - SFB53

13.1.3 Data Block 1 (DB1)

| Address | Name | Type | Initial value | Comment |
|---------|------------------------|------------|---------------|---|
| 0.0 | | STRUCT | | |
| +0.0 | Request_reference | BYTE | B#16#0 | Request header:unique identification of the request/response. |
| +1.0 | Request_ID | BYTE | B#16#2 | Request header:0x01=request parameter,0x02=change parameter |
| +2.0 | Axis_No_DO_ID | BYTE | B#16#0 | Request header:DO addressing for multi-axis or modular device |
| +3.0 | No_of_parameters | BYTE | B#16#1 | Request header:number of parameters (range 0x01..0x27) |
| +4.0 | Attribute_parameter_01 | BYTE | B#16#10 | Parameter address:type of object (0x10=value) |
| +5.0 | No_of_elements_01 | BYTE | B#16#0 | Parameter address:nom. of elements(0=special function) |
| +6.0 | parameter_number_01 | WORD | W#16#3D3 | Parameter address |
| +8.0 | subindex | WORD | W#16#0 | Parameter address:subindex |
| +10.0 | Format | BYTE | B#16#43 | Parameter value:data type (0x43=doubly word) |
| +11.0 | No_of_value | BYTE | B#16#1 | Parameter value:number of following values |
| +12.0 | Value | DINT | L#32 | Parameter value |
| +16.0 | | END_STRUCT | | |

Figure 62 - DB1

13.1.4 Data Block 2 (DB2)

| Address | Name | Type | Initial value | Comment |
|---------|--------------------------|------------|---------------|--|
| 0.0 | | STRUCT | | |
| +0.0 | Request_reference_mirror | BYTE | B#16#0 | Response header:mirroring of the request_reference |
| +1.0 | Response_ID | BYTE | B#16#0 | Response header:0x01=request parameter |
| +2.0 | Axis_No_DO_ID_mirrored | BYTE | B#16#0 | Response header:axis mirrored |
| +3.0 | No_of_parameters | BYTE | B#16#0 | Response header:number of parameters |
| +4.0 | Format | BYTE | B#16#0 | Parameter value:data type |
| +5.0 | No_of_value | BYTE | B#16#0 | Parameter value:number of following values |
| +6.0 | Value | DWORD | DW#16#0 | Parameter value:parameter value |
| +10.0 | | END_STRUCT | | |

Figure 63 - DB2

13.1.5 Data Block 3 (DB3)

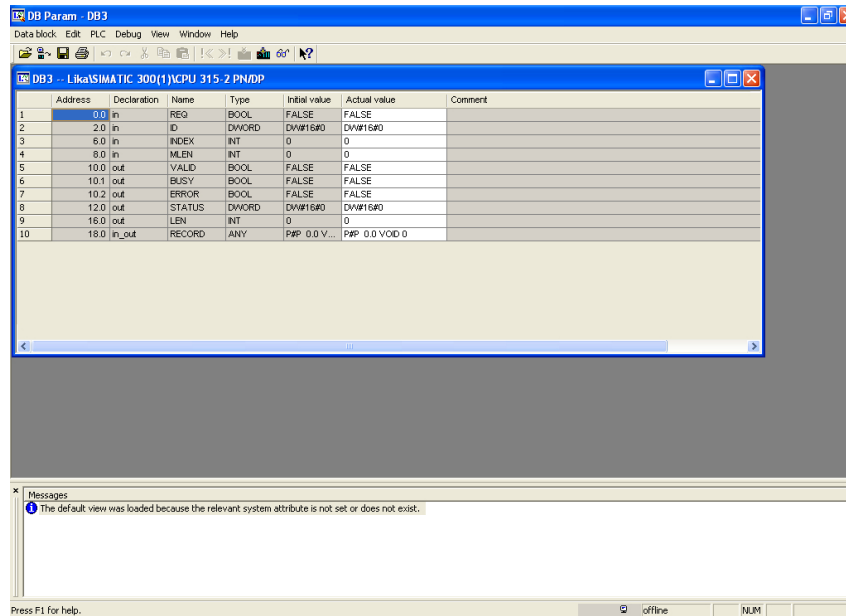

Figure 64 - DB3

13.1.6 Data Block 4 (DB4)

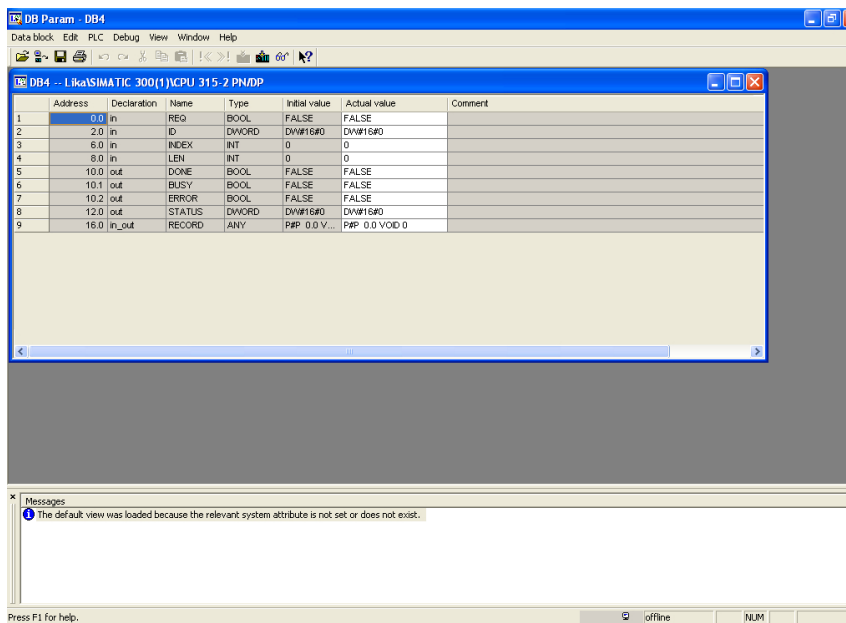

Figure 65 - DB4

13.1.7 Organization Block 1 (OB1)

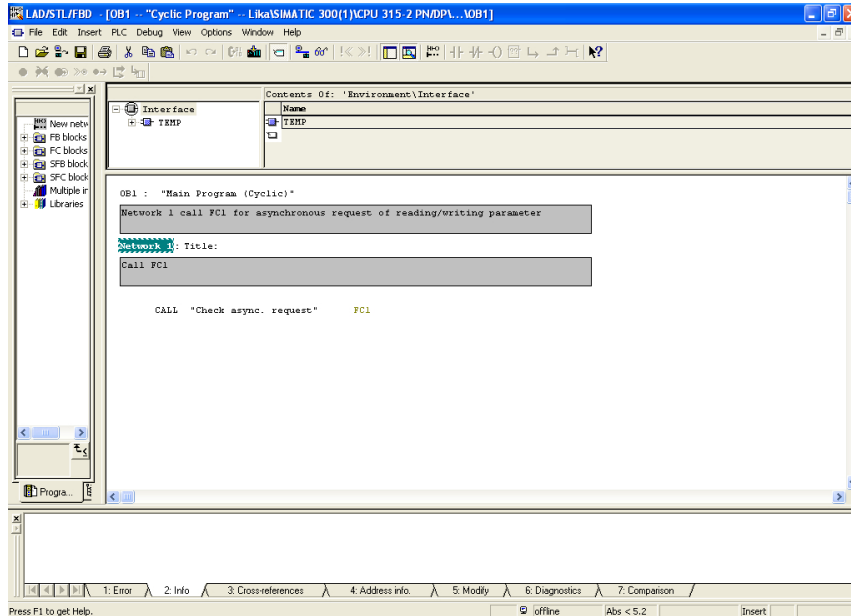

Figure 66 – OB1

13.1.8 Function 1 (FC1)

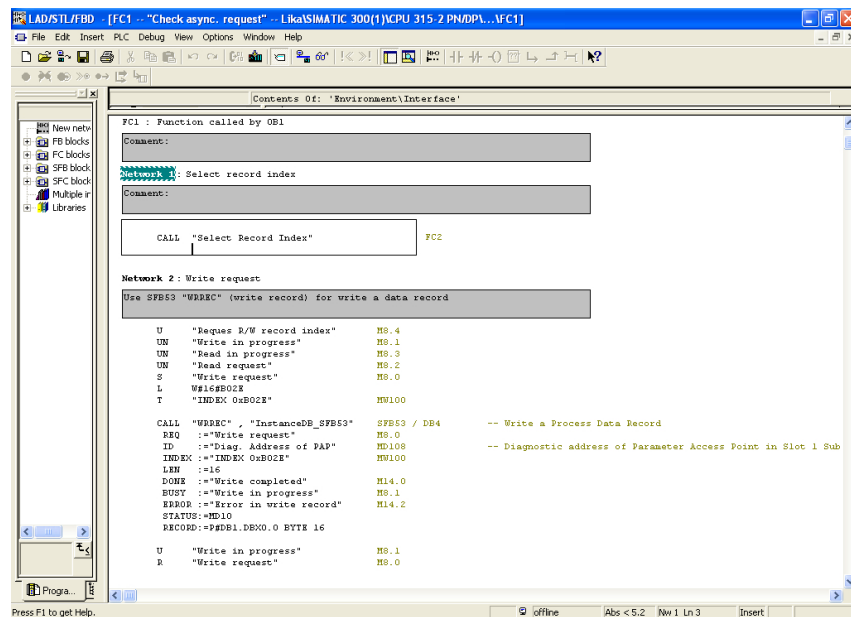

Figure 67 – FC1

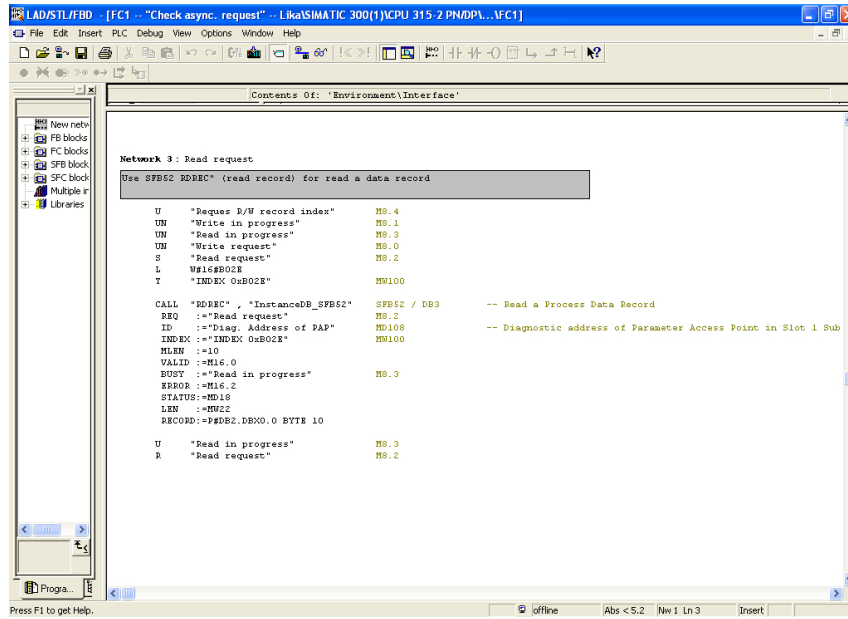

Figure 68 – FC1

13.1.9 Function 2 (FC2)

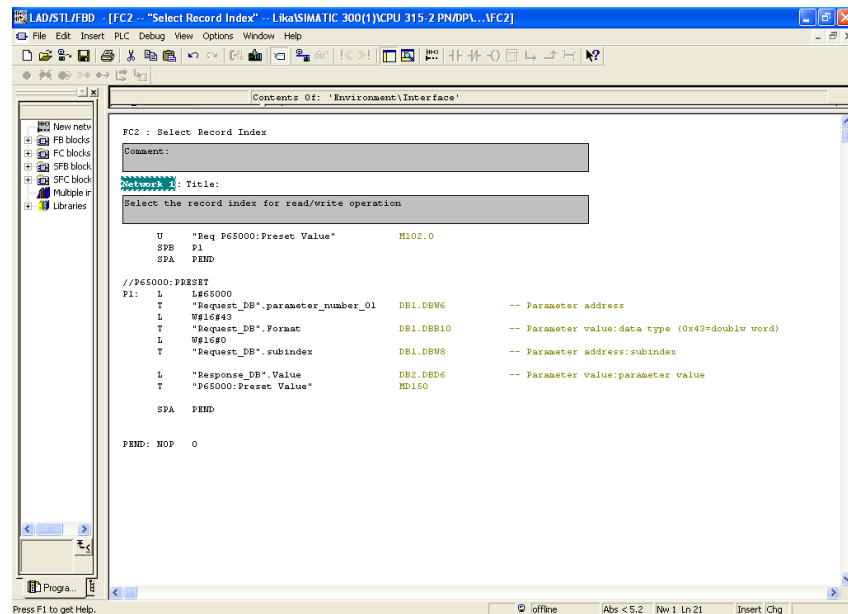

Figure 69 – FC2

13.1.10 Acyclic request of Preset

See P65000 – Preset value on page 87.

| Address | Symbol | Symbol comment | Display format | Status value | Modify value |
|------------|---|--|----------------|----------------|----------------|
| 1 | /encoder(2038=0x27F6) | | | | |
| MD 108 | "Diag. Address of PAP" | Diagnostic address of Parameter Access Point in Slot ... | DEC | LP2038 | LP2038 |
| 3 | /Request type:1=read parameter, 2=write parameter | | | | |
| DB1 DBB 1 | "Request_DB" Request_ID | Request header:0:01=request parameter, 0x02=chang... | HEX | B#16#01 | B#16#01 |
| M 102.0 | "Req P65000.Preset Value" | | BOOL | true | |
| 8 | /Value write | | | | |
| DB1 DBB 12 | "Request_DB" Value | Parameter value | HEX | DW#16#00000000 | DW#16#00000000 |
| 10 | /Value read | | | | |
| MD 150 | "P65000.Preset Value" | | HEX | DW#16#00000000 | |

Figure 70 – Acyclic request of Preset value



NOTE

Please always ascertain that MD 108 Diag. Address of PAP is the same as the diagnostic address of Parameter Access Point in Slot 1.1.

The screenshot shows the HW Config window for a SIMATIC 300(1) system. The hardware configuration includes a CPU 315-2 PN/DP and a Multibus 30 Bit Module. The variable table from Figure 70 is overlaid on the right. Red circles highlight the 'Diag. Address of PAP' (MD 108) in the variable table and the 'Multibus 30 Bit Module' in the hardware configuration, with a red arrow pointing from the module to the variable table entry.

13.2 Monitoring a variable

Below is an example of variable monitor in case of Telegram 83 and IRT communication.



NOTE
Controller Sign-Of-Life is active.

| Address | Symbol | Symbol comment | Display format | Status value | Modify value |
|---|---------------|--|----------------|-----------------------|-----------------------|
| /===== STANDARD TELEGRAM 83 ===== | | | | | |
| /===== OUTPUT DATA (CONTROLLER => DEVICE) ===== | | | | | |
| AW 0 | "STW2_ENC" | Encoder control word | BN | 2#0000_0100_0000_0000 | 2#0000_0000_0000_0000 |
| A 0.2 | "STW2_ENC.10" | Control by PLC | BOOL | true | true |
| AW 2 | "GH_STW" | Sensor 1 control word | HEX | VW#16#2000 | |
| A 2.3 | "GH_STW.11" | Home position mode (0=absolute,1=relative) | BOOL | false | |
| A 2.4 | "GH_STW.12" | Set this bit for preset position (if enabled) | BOOL | false | |
| A 2.5 | "GH_STW.13" | Transmit absolute value cyclically | BOOL | true | true |
| A 2.6 | "GH_STW.14" | Activate parking sensor | BOOL | false | |
| A 2.7 | "GH_STW.15" | Acknowledging a sensor error | BOOL | false | |
| /===== INPUT DATA (DEVICE => CONTROLLER) ===== | | | | | |
| BW 0 | "ZSW2_ENC" | Encoder status word | BN | 2#0000_0000_0000_0000 | |
| BW 2 | "GH_ZSW" | Sensor status word | HEX | VW#16#2000 | |
| E 2.3 | "GH_ZSW.11" | Error ack detected | BOOL | false | |
| E 2.4 | "GH_ZSW.12" | preset executed | BOOL | false | |
| E 2.5 | "GH_ZSW.13" | Enc. is transmitting position value cyclically | BOOL | true | |
| E 2.6 | "GH_ZSW.14" | Parking sensor active | BOOL | false | |
| E 2.7 | "GH_ZSW.15" | Sensor error | BOOL | false | |
| ED 4 | "GH_XIS11" | Enc. position value | HEX | DW#16#0DA0A064 | |
| ED 8 | "GH_XIS12" | Enc. position value/error telegram | HEX | DW#16#0DA0A064 | |
| ED 12 | "NST_B" | Velocity 32 bit | DEC | L#0 | |

Figure 71 - Monitoring a variable

14 Encoder state machine

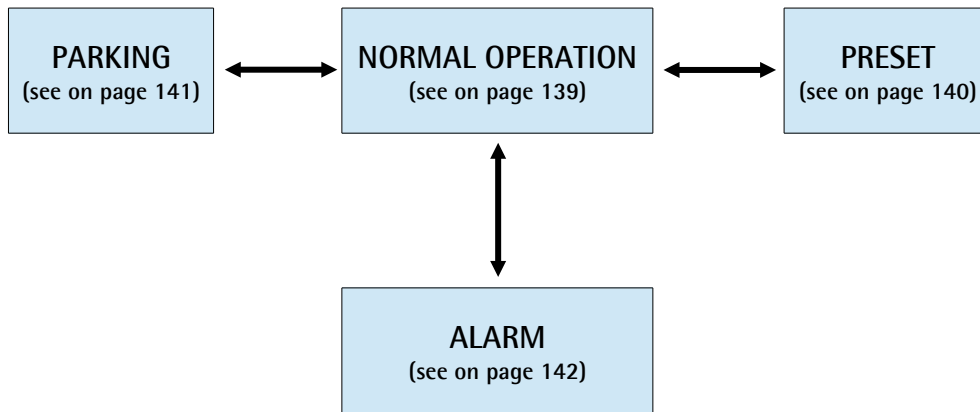
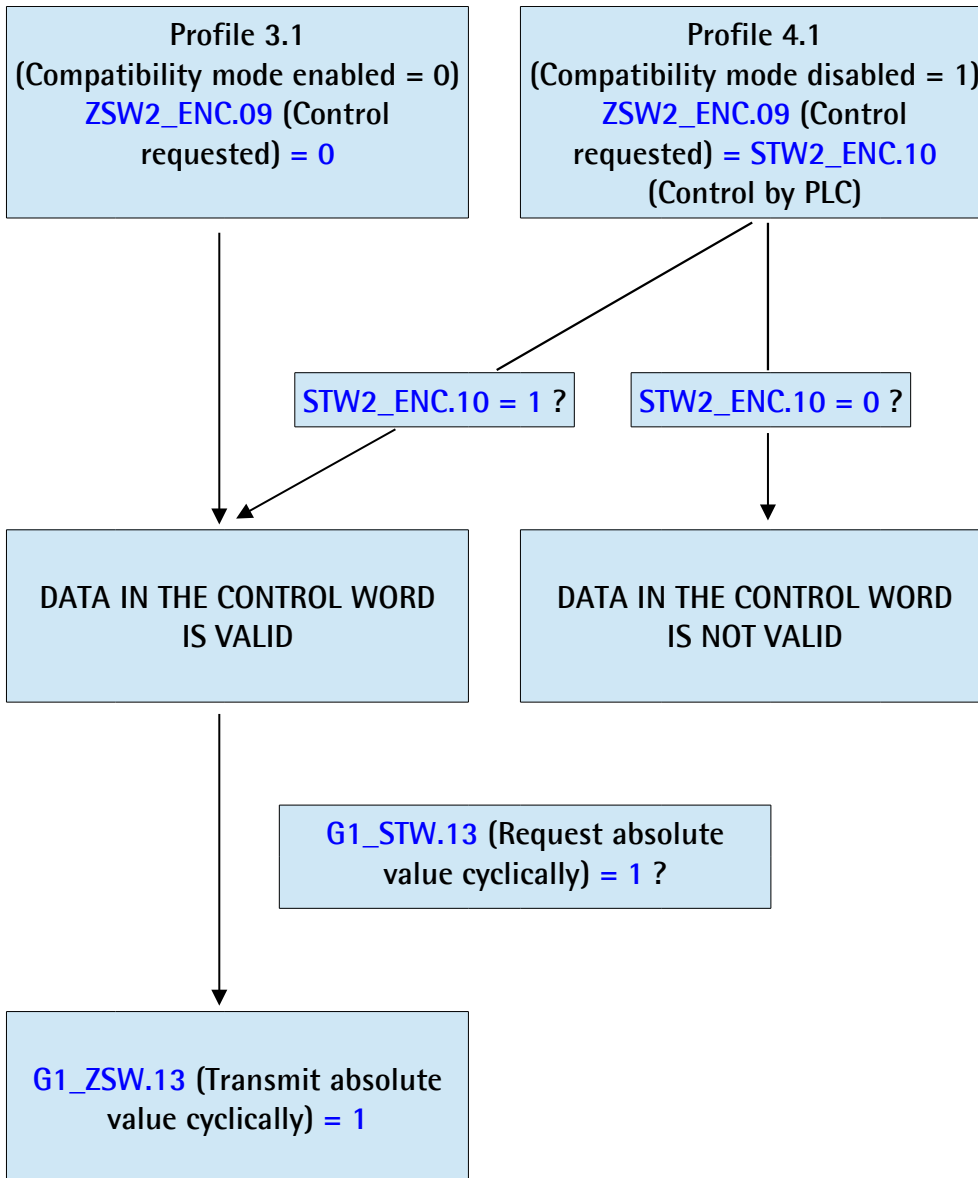
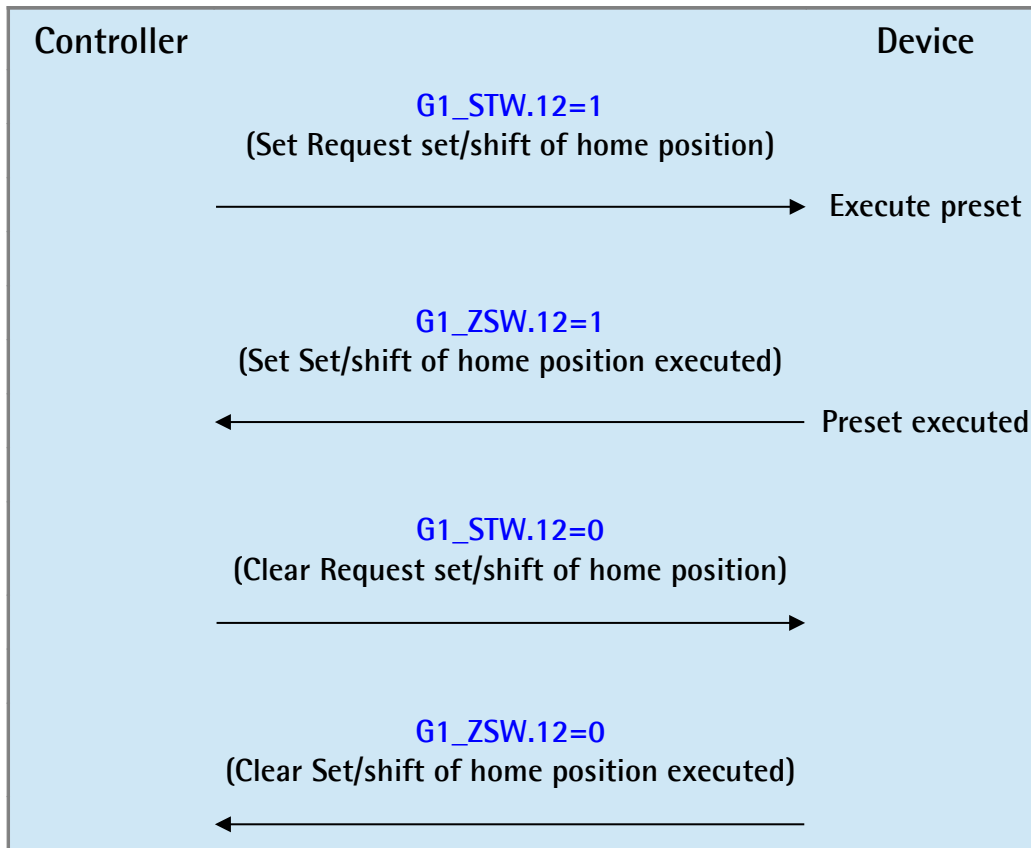

Figure 72 - Encoder state machine

14.1 Normal operation diagram



14.2 Preset diagram



14.3 Parking sensor diagram

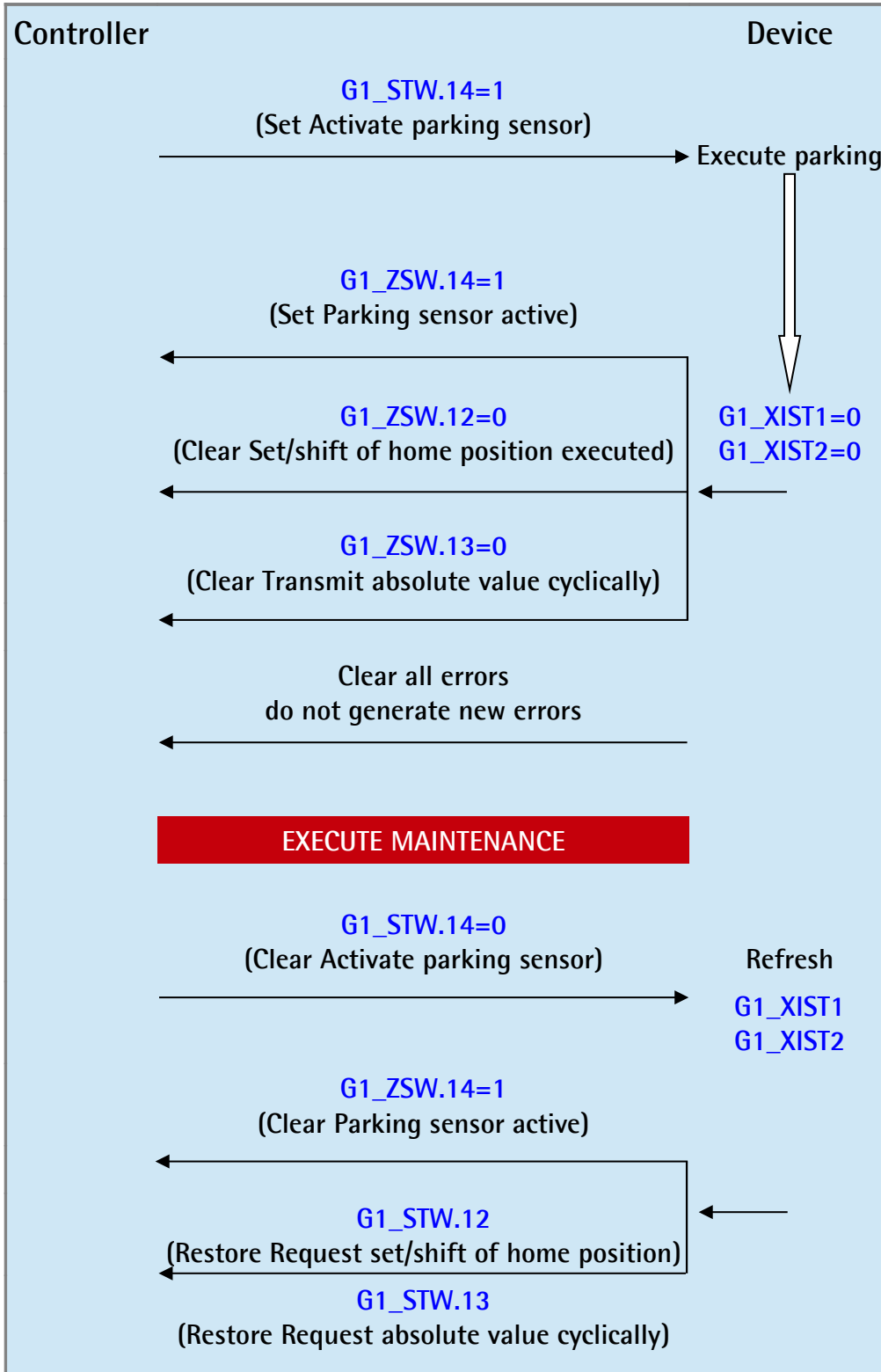

14.4 Error diagram

14.4.1 Acknowledgement of acknowledgeable sensor error

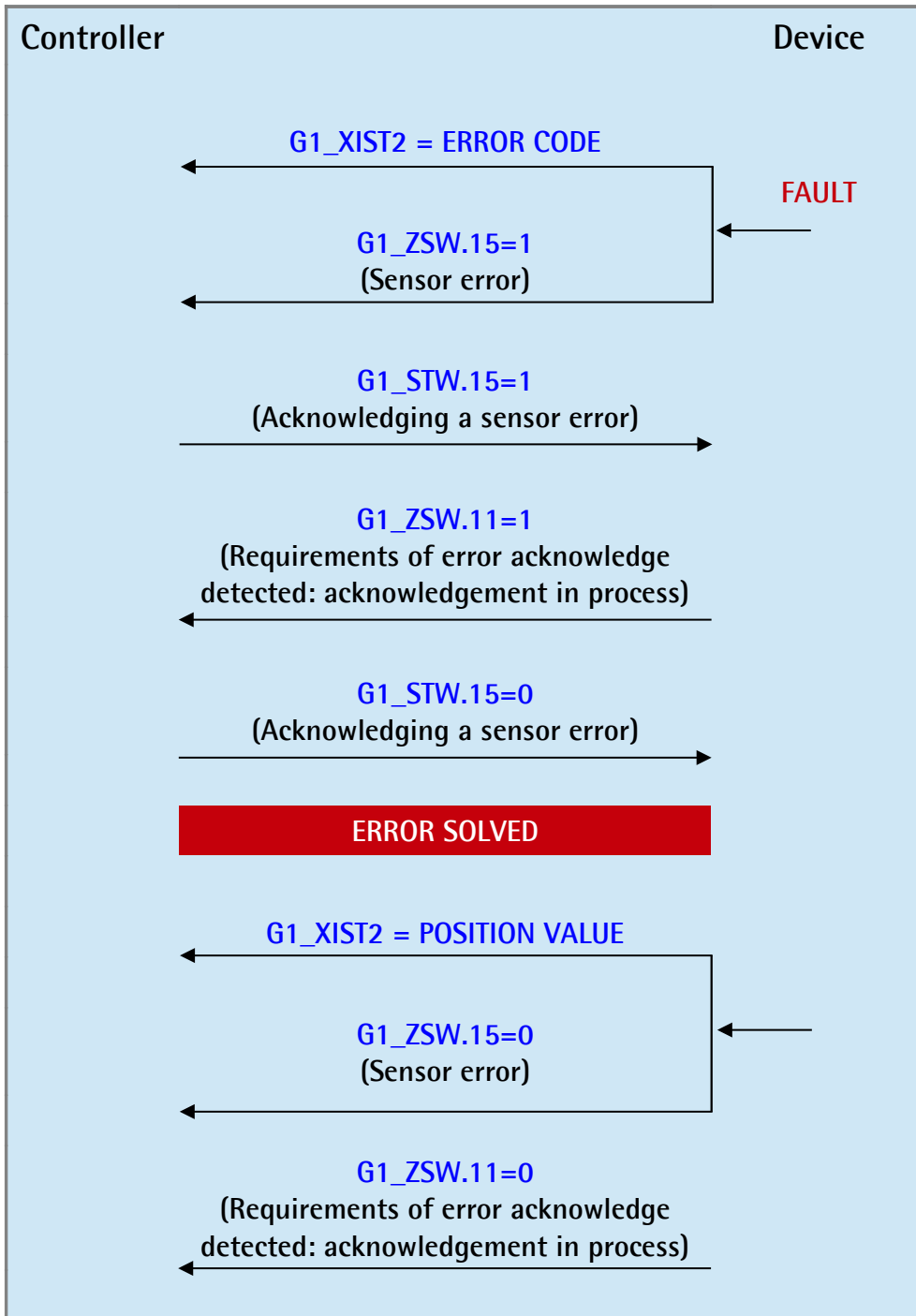

14.4.2 Acknowledgement of not acknowledgeable sensor error

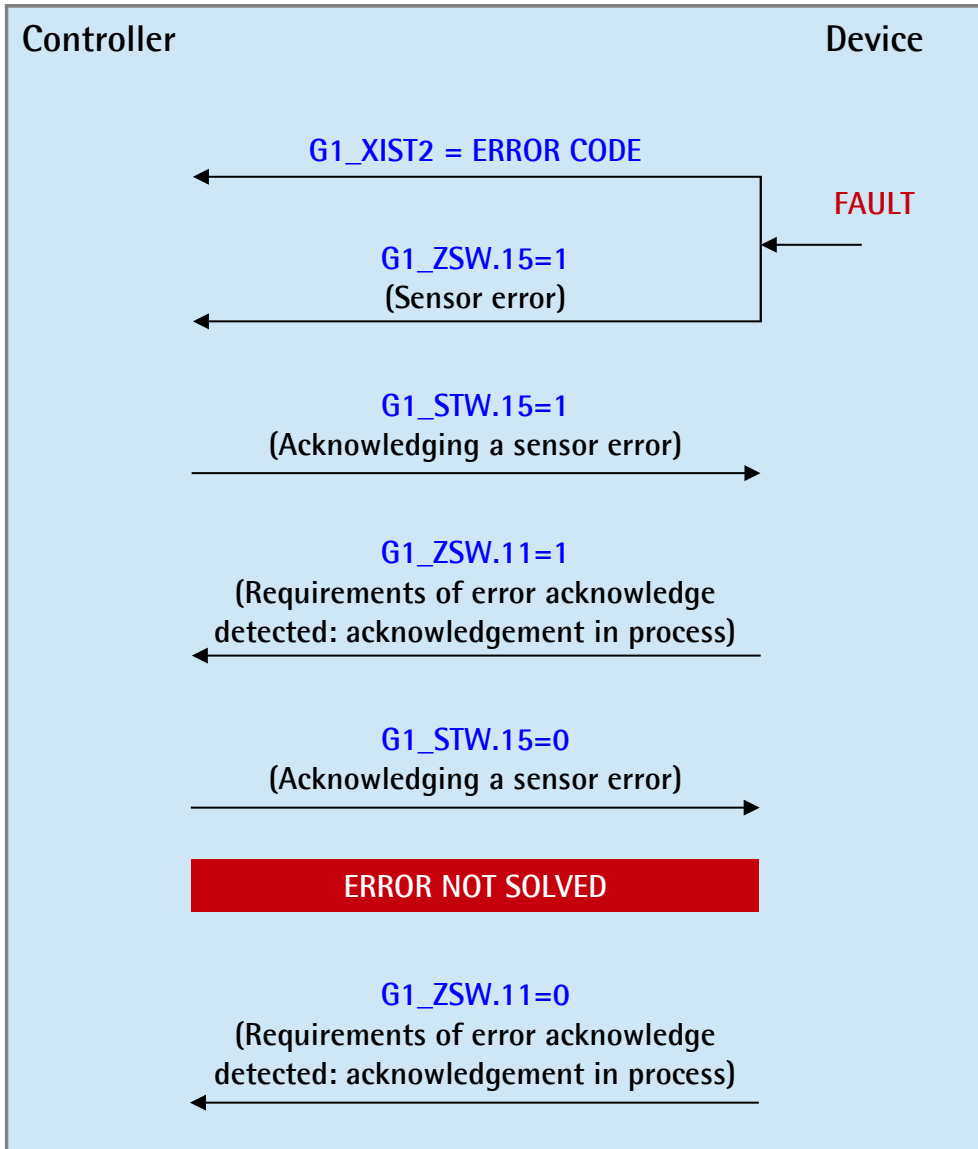

15 Integrated web server

Profinet encoders from Lika Electronic integrate a web server. This web-based user interface is designed to deliver helpful information on the device that can be accessed through the Internet. In particular it makes monitoring and advanced maintenance of the encoder from every PC running a web browser possible. Since its only requirement is a HTTP connection between the web browser and the web server running on the device, it is perfectly fitted also for remote access scenarios.

Before opening the Profinet encoder web server please ascertain that the following requirements are fully satisfied:

- the encoder is connected to the network;
- the encoder has valid device name and IP address;
- the PC is connected to the network;
- a web browser (Internet Explorer, Mozilla Firefox, Google Chrome, Opera, ...) is installed in the PC or in the device used for connection.



NOTE

This web server has been tested and verified using the following web browsers:

- Internet Explorer IE7 version 7.0.5730.13
- Mozilla Firefox version 28.0
- Google Chrome version 33.0.1847.116 m
- Opera version 20.0.1387.91



NOTE

Please note that the snapshot look may vary depending on the used web browser. The following snapshots have been taken from Internet Explorer.

To open the Profinet encoder web server proceed as follows:

1. type the IP address of the encoder you want to connect to (in the example: 192.168.20.195) in the address bar of your web browser and confirm by pressing **ENTER**;

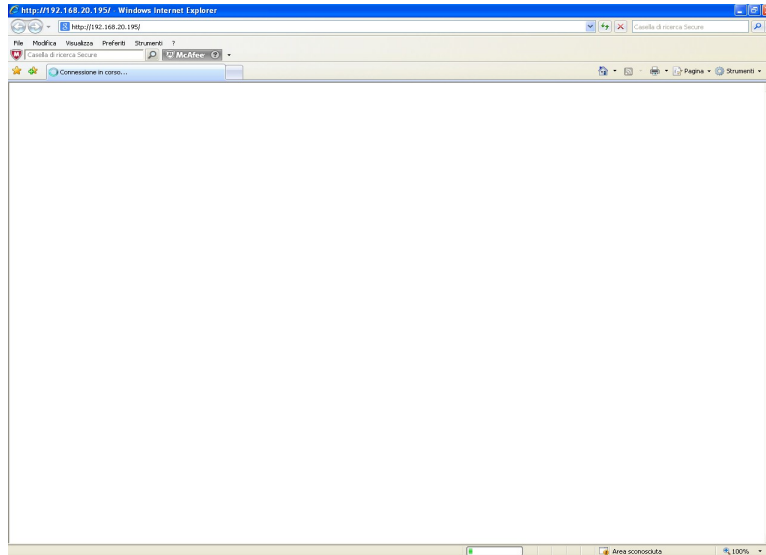

Figure 73 – Opening the web server

2. as soon as the connection is established, the web server Home page will appear on the screen;



Figure 74 – Web server Home page

In the Home page some commands are available in the menu bar. Press the **website** command to enter Lika's web site (www.lika.biz). Press the **certificates** command to enter the Product certifications page on Lika's web site (http://www.lika.it/eng/certificazioni.php).

Furthermore some commands are available in the left navigation bar. The menu bar is divided into two sections: the commands in the above section allow to enter freely accessible pages; while the commands in the below section (under the label **Password protected menus**) allow to enter password protected pages.

These commands allow to enter specific pages where information and diagnostics on the connected encoder can be achieved.

They are shown in the following snapshots.

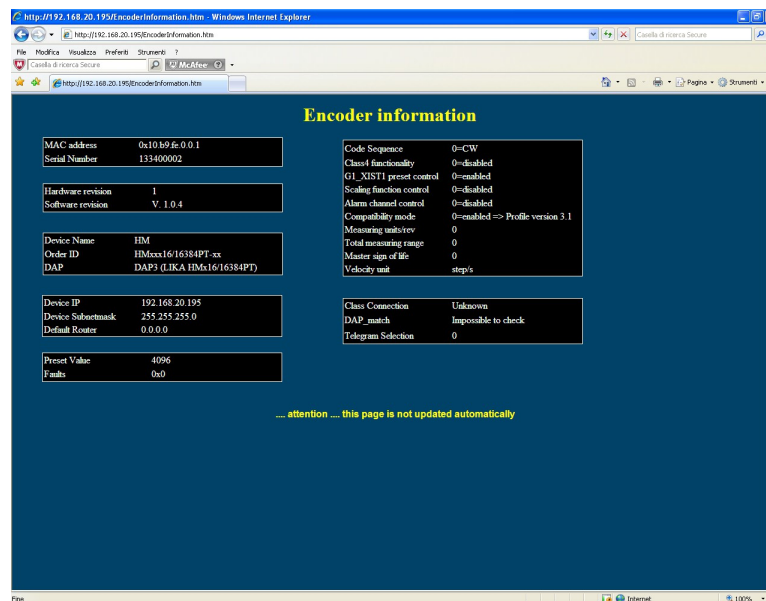

Figure 75 – Encoder Information page

Parameters listed in the **Encoder Information page** are sent by the controller to the encoder during initialization (for further information refer to the "9.4 Index 0xBF00 : user parameter data" section on page 90).

For further information on the encoder specific profile parameters refer to the sections "9.2 Index 0xB02E : supported PROFIdrive specific parameters" on page 84 and "9.3 Index 0xB02E : supported encoder specific parameters" on page 87.

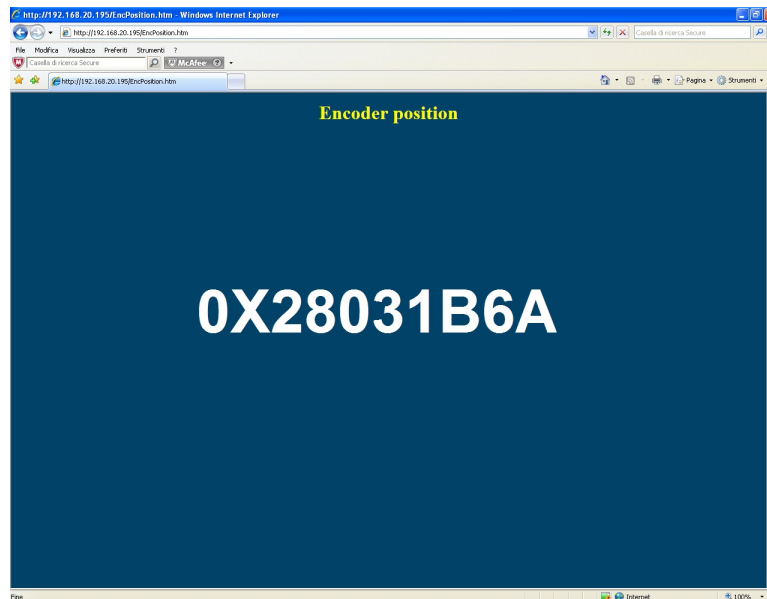

Figure 76 – Encoder position page

In the Encoder position page the current encoder position is shown.

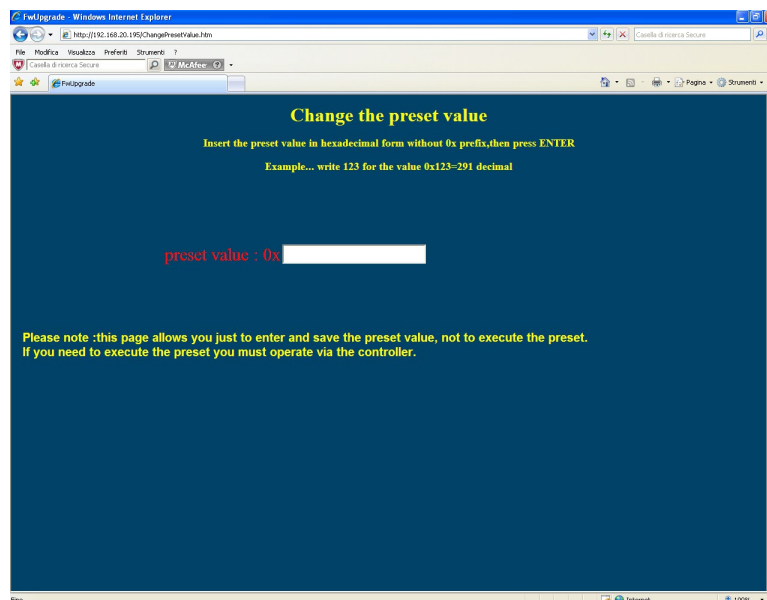

Figure 77 – Change the preset value page

For detailed information on setting the preset value please refer to the "15.2 Setting the preset value" section on page 156.

The **technical documentation** command allows to enter the web page (http://www.lika.it/eng/prodotti.php?id_cat=267&tid_fam=270&tid_sfam=492) in the corporate web site where specific technical information and documentation concerning the Profinet encoder can be found.

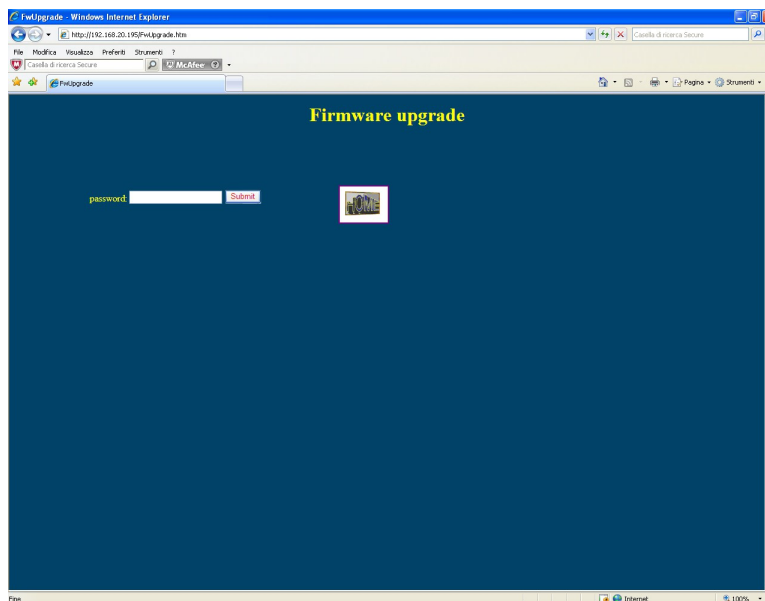

Figure 78 - Firmware upgrade page

This is a password protected page. For detailed information on the firmware upgrade please refer to the "15.1 Firmware upgrade" section on page 149.

15.1 Firmware upgrade



WARNING

Firmware upgrading process has to be accomplished by skilled and competent personnel. It is mandatory to perform the upgrade according to the instructions provided in this section.

Before installation always ascertain that the firmware program is compatible with the hardware and software of the device. Furthermore never turn off power during flash upgrade. In case of flash upgrade error, the program is lost irreversibly (there is not a bootloader) and the device must be sent back to Lika Electronic for restoring.

This operation allows to upgrade the unit firmware by downloading upgrading data to the flash memory.

Firmware is a software program which controls the functions and operation of a device; the firmware program, sometimes referred to as "user program", is stored in the flash memory integrated inside the unit. These encoders are designed so that the firmware can be easily updated by the user himself. This allows Lika Electronic to make new improved firmware programs available during the lifetime of the product.

Typical reasons for the release of new firmware programs are the necessity to make corrections, improve and even add new functionalities to the device.

The firmware upgrading program consists of a single file having .BIN extension. It is released by Lika Electronic Technical Assistance & After Sale Service.

If the latest firmware version is already installed in the unit, you do not need to proceed with any new firmware installation. Current firmware version can be verified in the Encoder Specific Profile Parameters page after connection to the web server.



NOTE

If you are not confident that you can perform the update successfully please contact Lika Electronic Technical Assistance & After Sale Service.

Before proceeding with the firmware upgrade please ascertain that the following requirements are fully satisfied:

- the encoder is connected to the network;
- the encoder has valid device name and IP address;
- the PC is connected both to the network and the IO controller;

- a web browser (Internet Explorer, Mozilla Firefox, Google Chrome, Opera, ...) is installed in the PC or device used for connection;
- you have the SW_PN.EXE executable file;
- you have the .BIN file for firmware upgrade.

To upgrade the firmware program please proceed as follows:

1. open the Profinet encoder web server by typing the IP address of the encoder you want to connect to (in the example: 192.168.20.195) in the address bar of your web browser and confirm by pressing **ENTER**;

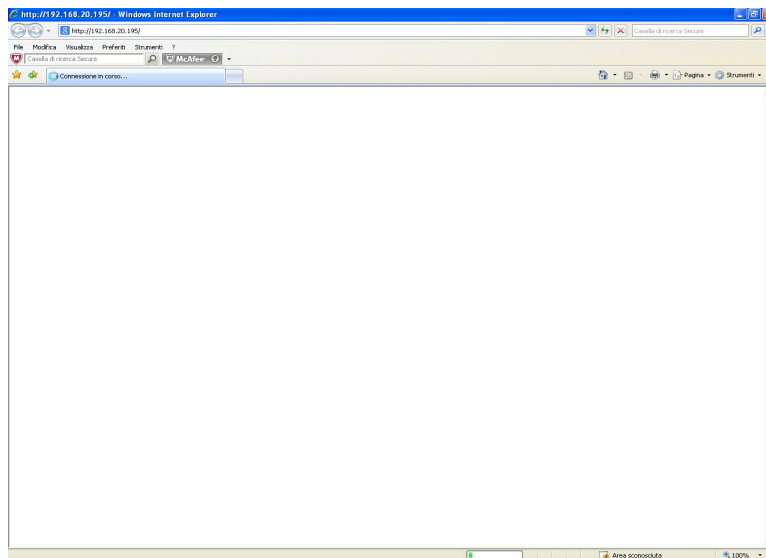

Figure 79 - Opening the web server

- in the Home page press the **Firmware upgrade** command to enter the **Firmware upgrade** page;



Figure 80 – Web server Home page

- before entering the page you are requested to confirm the operation; press **OK** to continue;

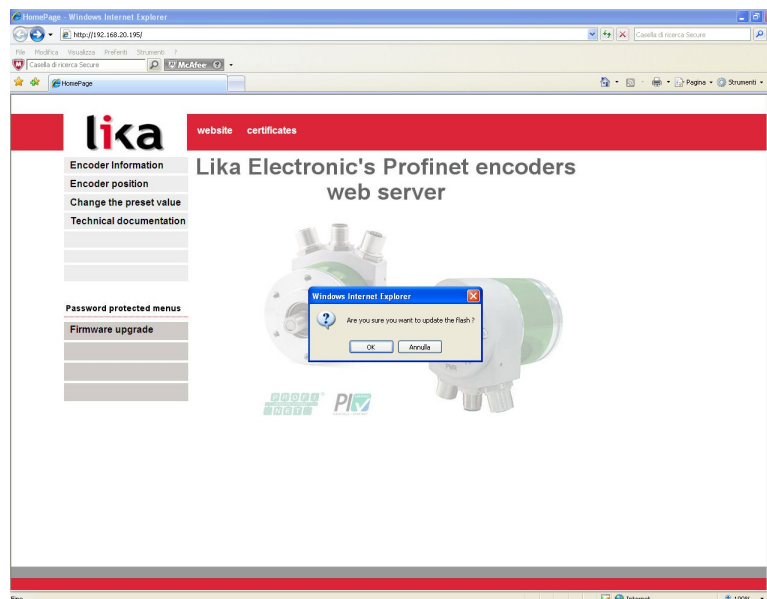

Figure 81 – Confirming the access to the Firmware upgrade page

4. in the **Password** text box type the password **lika** and then press the **Submit** button;

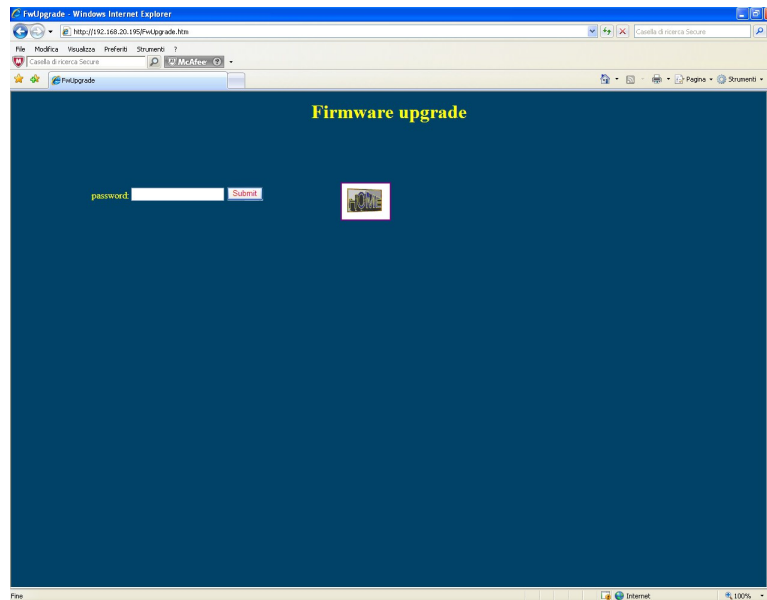

Figure 82 – Firmware upgrade page

5. a message will appear on the screen while the background colour of the page will be changed to red; now the web server is stopped and the encoder is ready to accept the firmware program;

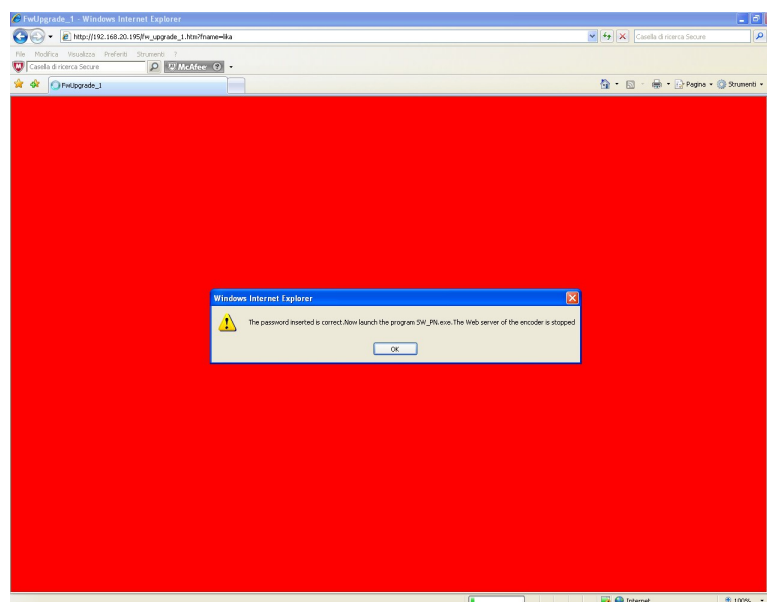

Figure 83 – Web server stopped

6. as soon as you press the **OK** button the following message will appear on the page: now you must launch the SW_PN.EXE executable file to continue with the procedure;

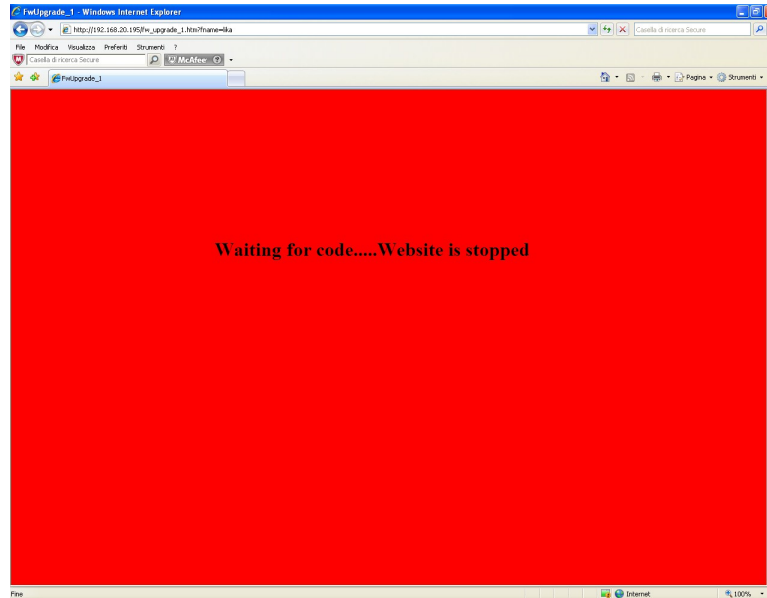

Figure 84 - Web server stopped

7. launch the SW_PN.EXE executable file provided with the technical documentation;
8. in the page that appears press the **SELECT FILE** button; once you press the button the **Open** dialogue box appears on the screen: open the folder where the firmware upgrading .BIN file released by Lika Electronic is located, select the file and confirm;

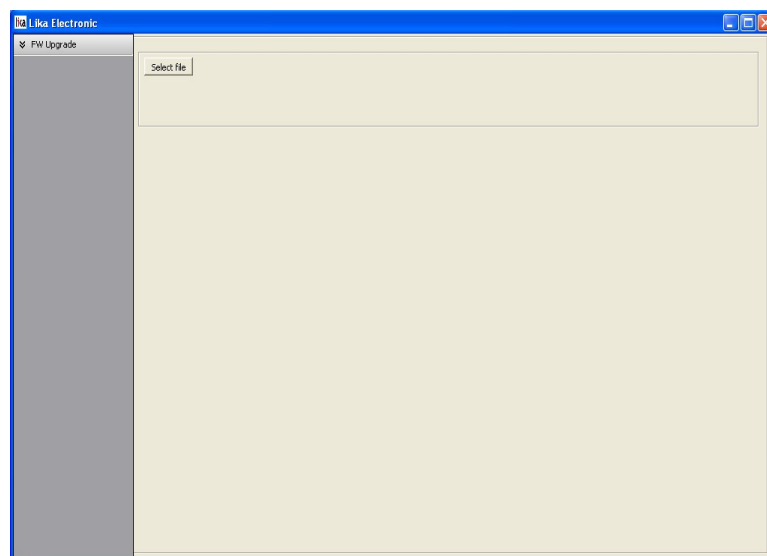

Figure 85 - Firmware upgrade executable file

9. in the **Remote host** text box type the IP address of the encoder you need to update; leave the **Remote port** box unchanged;
10. to start the upgrade press the **Upgrade FW** button;

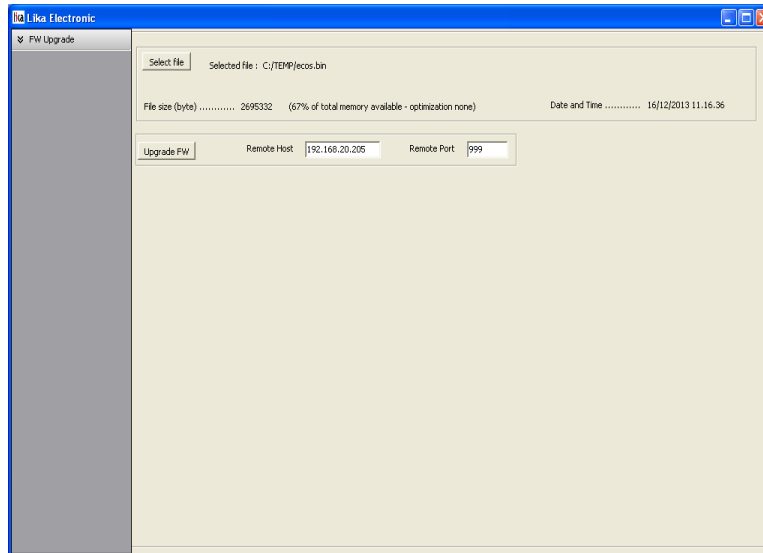

Figure 86 - Starting the firmware upgrade operation



WARNING

Before installation always ascertain that the firmware program is compatible with the hardware and software of the device.

Never turn off power during flash upgrade.

In case of flash upgrade error, the program is lost irreversibly (there is not a bootloader) and the device must be sent back to Lika Electronic for restoring.

- download progress bars and additional information are shown in the page during operation;

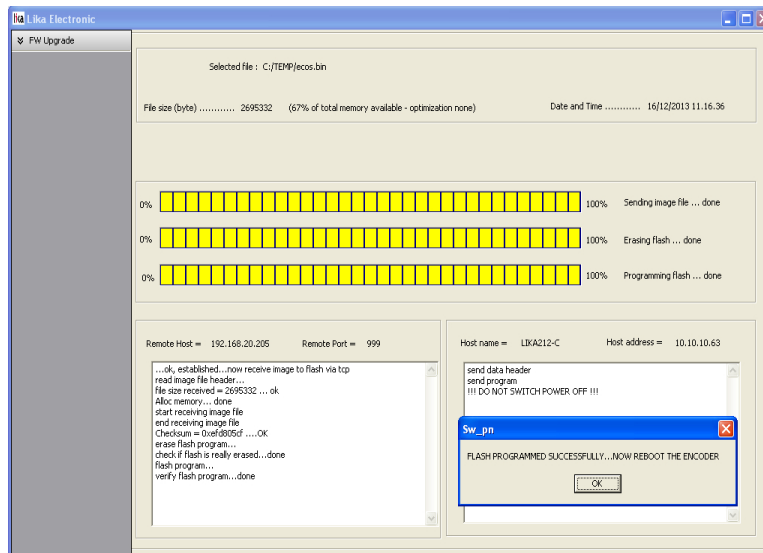

Figure 87 - Firmware upgrade operation process

- during download operation S1 Status 1 LED starts blinking green at 1 Hz while S2 Status 2 LED is OFF (see on page 32);
- as soon as the operation is carried out successfully, the FLASH PROGRAMMED SUCCESSFULLY message appears on the screen;
- turn encoder power = off and then on to complete the operation.



NOTE

While downloading the firmware upgrading program, unexpected conditions may arise which could lead to a failure of the installation process. When such a matter occurs, download process cannot be carried out successfully and thus the operation is aborted; S2 Status 2 LED starts blinking red at 1 Hz while S1 Status 1 LED is OFF (see on page 32). In case of flash upgrade error, the program is lost irreversibly (there is not a bootloader) and the device must be sent back to Lika Electronic for restoring.

15.2 Setting the preset value



NOTE

This page is designed to help you setting a Preset value easily. Please note it allows you just to enter and save the value, not to execute the preset. If you need to execute the preset you must set the bit 12 (**Request set/shift of home position**) of the **G1_STW** control word (see on page 78). Refer also to the index **P65000 – Preset value** on page 87; to **G1_XIST1 preset control** on page 91; and to the "14.2 Preset diagram" section on page 140. In a customary way you should always use the asynchronous transmission to set the preset value. Using this page the preset value is stored automatically on the non volatile memory (you do not need to use the parameter **P971 – Transfer to non volatile memory**).

To enter a preset value please proceed as follows:

1. open the Profinet encoder web server by typing the IP address of the encoder you want to connect to (in the example: 192.168.20.195) in the address bar of your web browser and confirm by pressing **ENTER**;

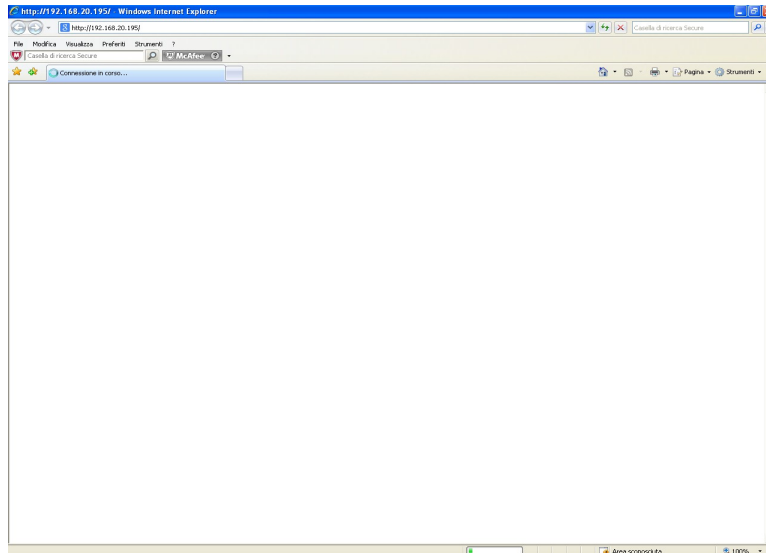

Figure 88 – Opening the web server

- in the Home page press the **Change the preset value** command to enter the **Change the preset value** page;



Figure 89 – Web server Home page

- before entering the page you are requested to confirm the operation; press **OK** to continue;

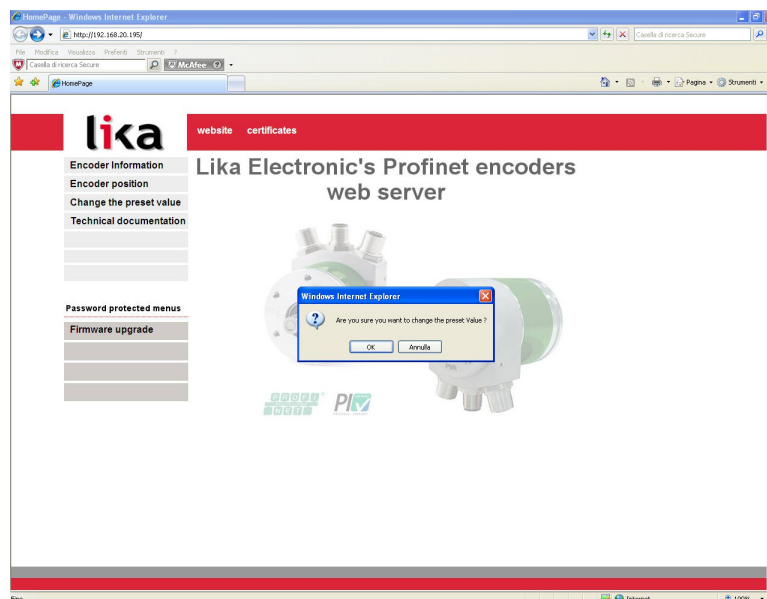

Figure 90 – Confirming the access to the Preset page

4. in the page that appears you have to enter the desired preset value expressed in hexadecimal format; please enter the value without the 0x prefix. Press **ENTER** to confirm. In the example, the value 0x1000 hex (= 4096 dec) is entered. The preset value is stored automatically on the non volatile memory (you do not need to use the parameter **P971 – Transfer to non volatile memory**);

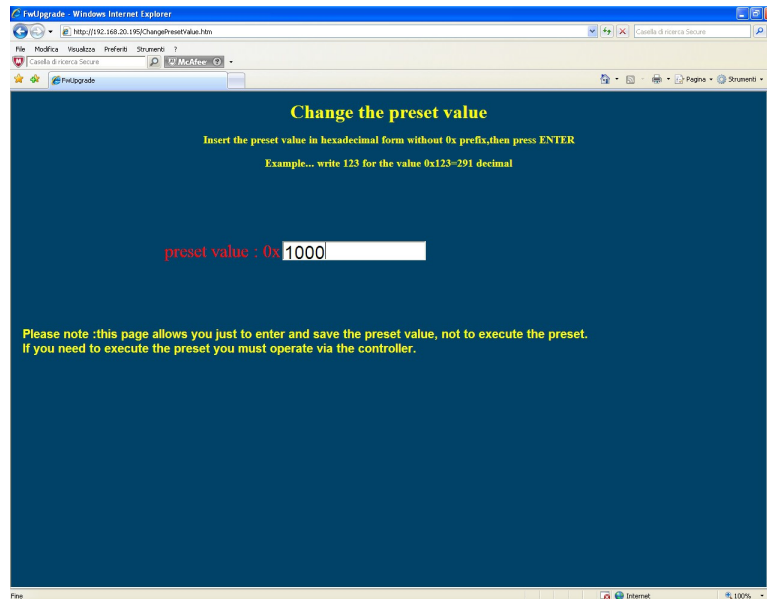

Figure 91 - Changing the Preset value

5. after completing the operation the following page will appear: the preset value has been stored properly on the non volatile memory.

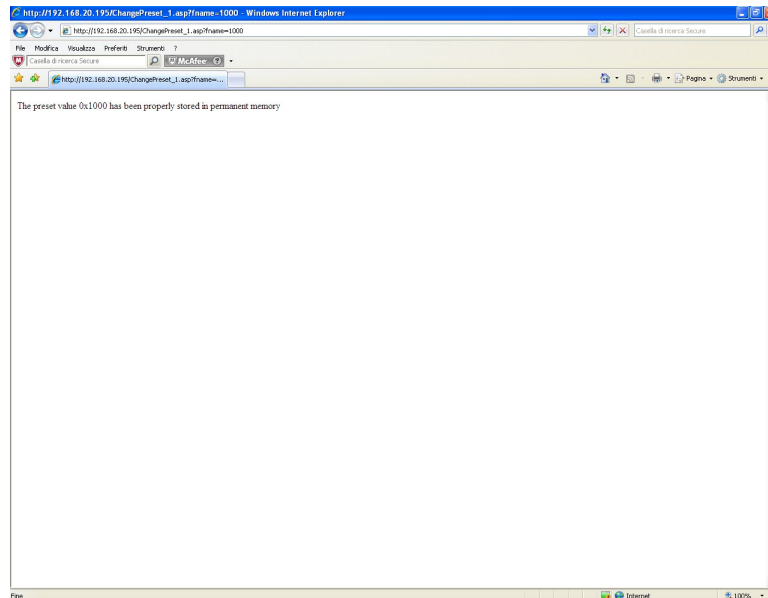

Figure 92 – Preset value stored properly

6. if you try to enter a preset value that is already stored on the memory the following message will be returned.

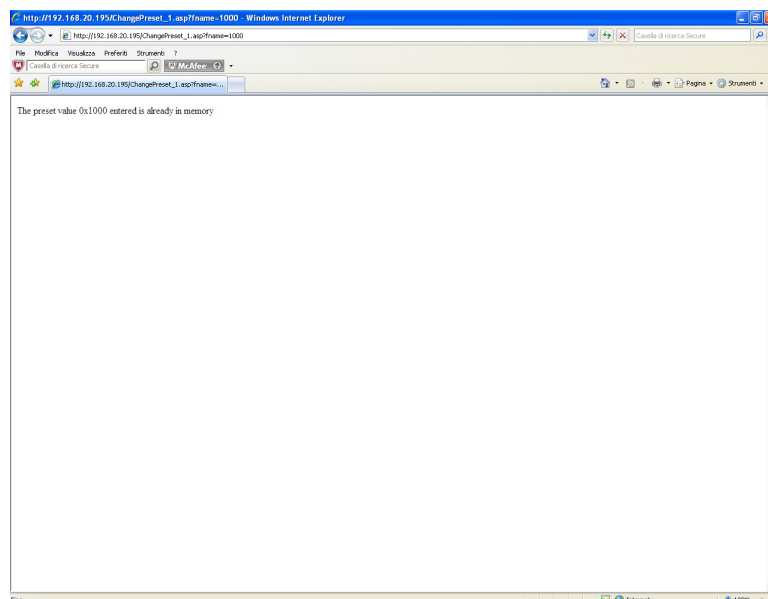

Figure 93 – Preset value already stored

16 Default parameters list

| Parameters list | Default value | | |
|--------------------------------------|--------------------------------|--|--|
| Code sequence | 0 | | |
| Class 4 functionality | 1 | | |
| G1_XIST1 preset control | 0 | | |
| Scaling function control | 0 | | |
| Alarm channel control | 0 | | |
| Compatibility mode | 1 | | |
| Measuring units / Revolution | Hardware singleturn resolution | | |
| Total measuring range | Hardware total resolution | | |
| Maximum Master Sign-Of-Life failures | 1 | | |
| Velocity measuring units | 0 | | |

This page intentionally left blank

This page intentionally left blank

This page intentionally left blank

| Document release | Release date | Description | HW | SW | GSDML file version |
|------------------|--------------|---|----|-------|------------------------------|
| 1.0 | 10.01.2014 | First issue | 1 | 1.0.1 | From release 20131024 to ... |
| 1.1 | 07.02.2014 | Profinet certificates | 1 | 1.0.1 | From release 20131024 to ... |
| 1.2 | 10.03.2014 | Firmware upgrade, section 15 "Integrated web server" updated | 1 | 1.0.2 | From release 20131024 to ... |
| 1.3 | 15.04.2014 | Firmware upgrade, section 15 "Integrated web server" updated | 1 | 1.0.3 | From release 20131024 to ... |
| 1.4 | 17.04.2014 | Firmware upgrade, section 15 "Integrated web server" updated | 1 | 1.0.4 | From release 20131024 to ... |
| 1.4 | 09.09.2014 | Reading of the Preset value sent in asynchronous communication mode corrected (09_14) | 1 | 1.0.5 | From release 20131024 to ... |
| 1.5 | 30.11.2016 | General review | 1 | 1.0.5 | From release 20131024 to ... |
| 1.6 | 29.07.2019 | Information about TO Technology Objects added (page 64) | 1 | 1.0.5 | From release 20131024 to ... |



This device is to be supplied by a Class 2 Circuit or Low-Voltage Limited Energy or Energy Source not exceeding 30 Vdc. Refer to the order code for supply voltage rate.

Ce dispositif doit être alimenté par un circuit de Classe 2 ou à très basse tension ou bien en appliquant une tension maxi de 30Vcc. Voir le code de commande pour la tension d'alimentation.



Dispose separately

lika

Lika Electronic

Via S. Lorenzo, 25 • 36010 Carrè (VI) • Italy

Tel. +39 0445 806600

Fax +39 0445 806699



info@lika.biz • www.lika.biz